

SMART RN 145 > 13HM76KN600 (2017) > FAHRANTRIEB, VARIATOR

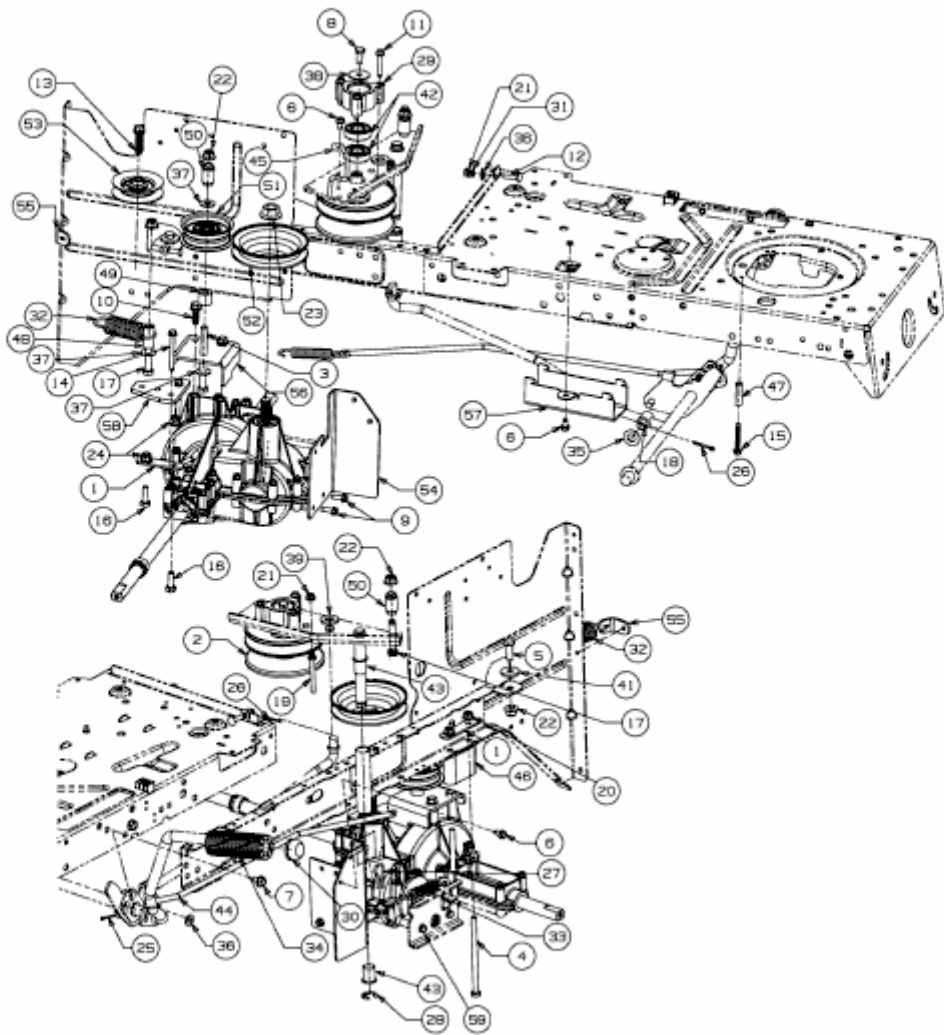

E3-03858I-01