

SMART RN 145 > 13HM76KN600 (2017) > LENKUNG

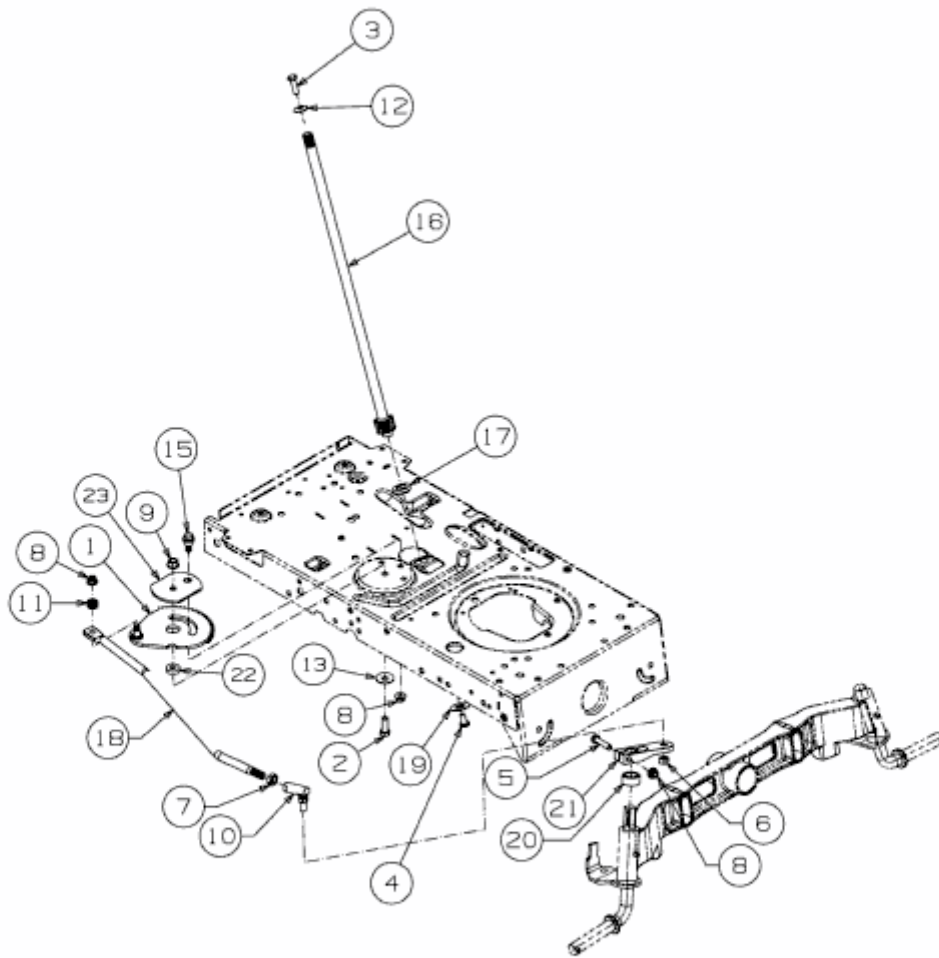

E3-03840G-01