

SMART RN 145 > 13HM76KN600 (2017) > MOTORKEILRIEMENSCHLEIBE

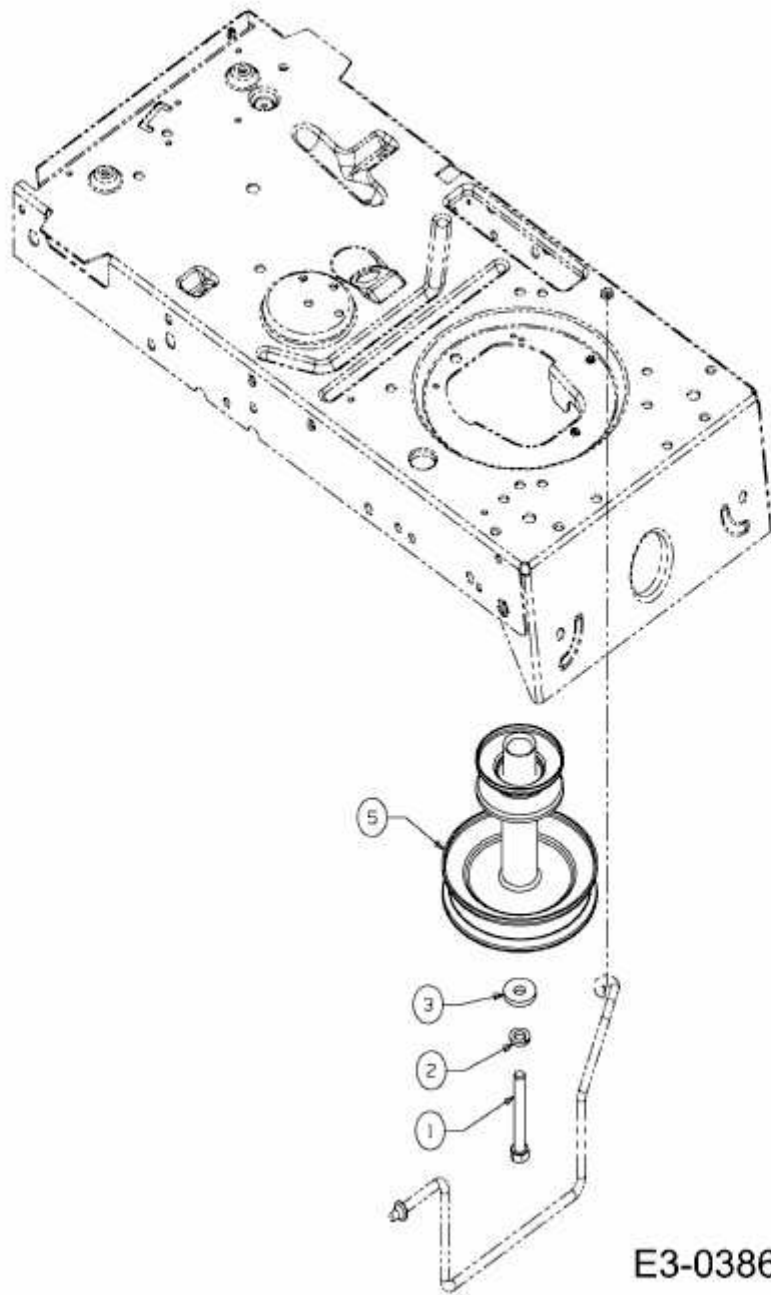

E3-03869A-01