

SMART RN 145 > 13HM76KN600 (2017) > BREMSE

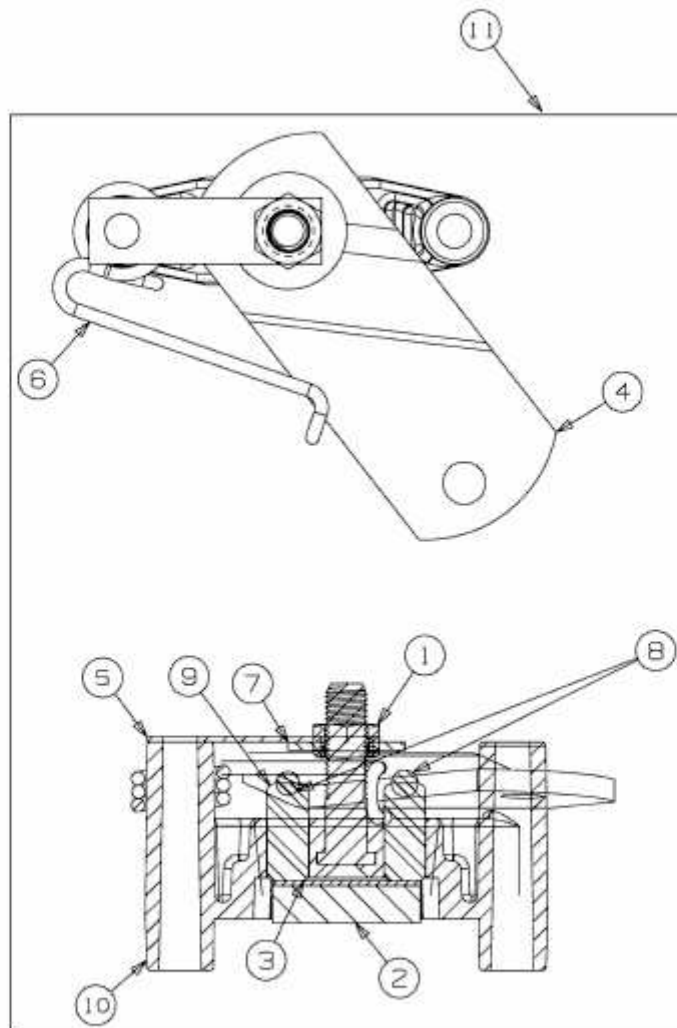

E3-03859G-03