

SMART RN 145 > 13HM76KN600 (2017) > FAHRANTRIEB, PEDAL, SCHALTHEBEL

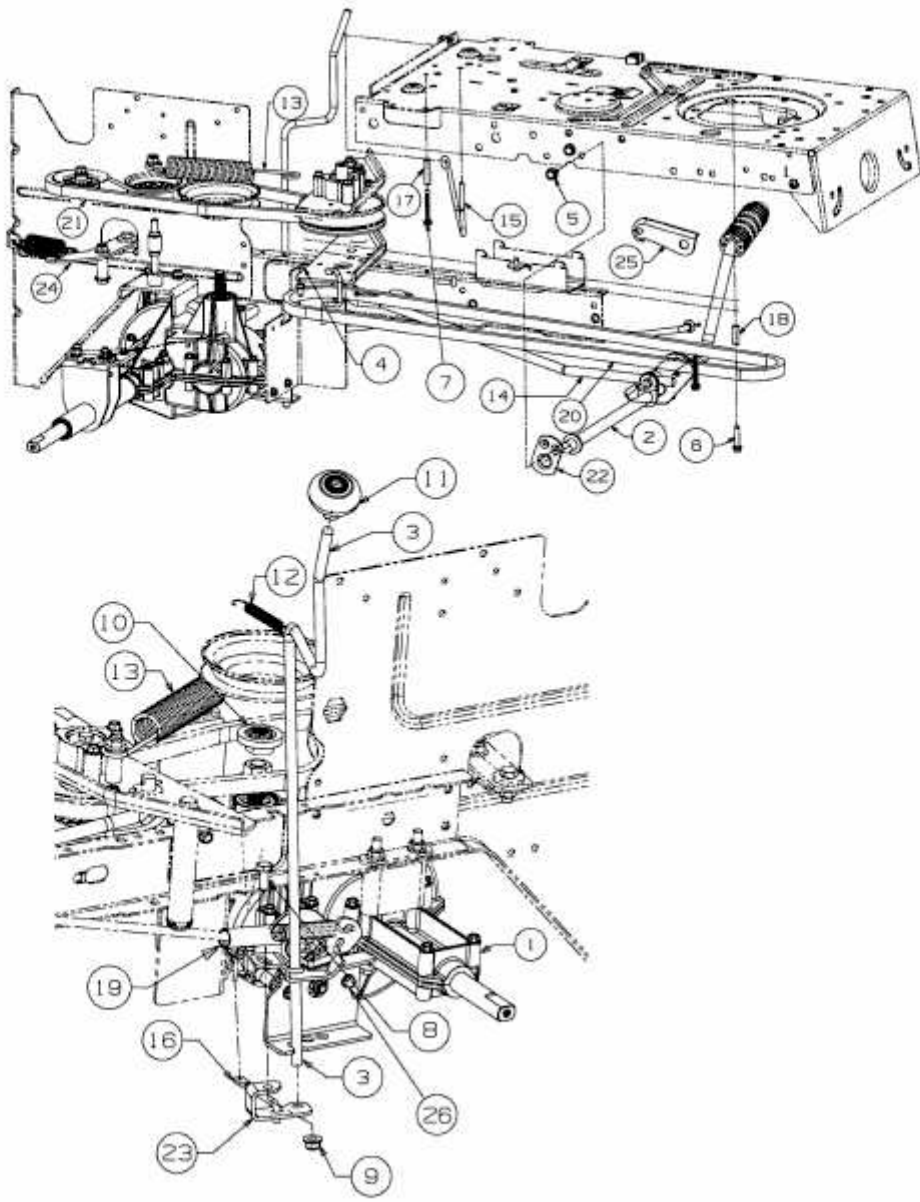

E3-03859G-01