

SMART RN 145 > 13HM76KN600 (2017) > GESCHWINDIGKEITSREGELUNG

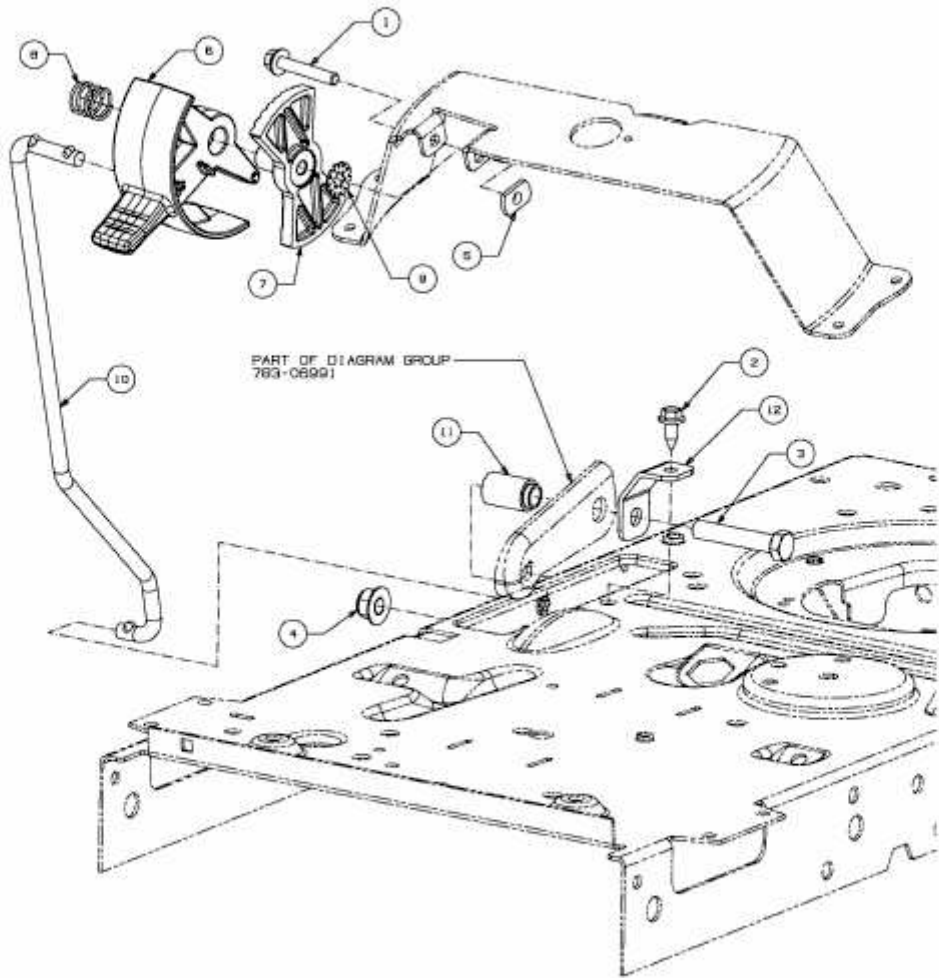

E3-07438B-01