

SMART RN 145 > 13HM76KN600 (2017) > LENKRAD

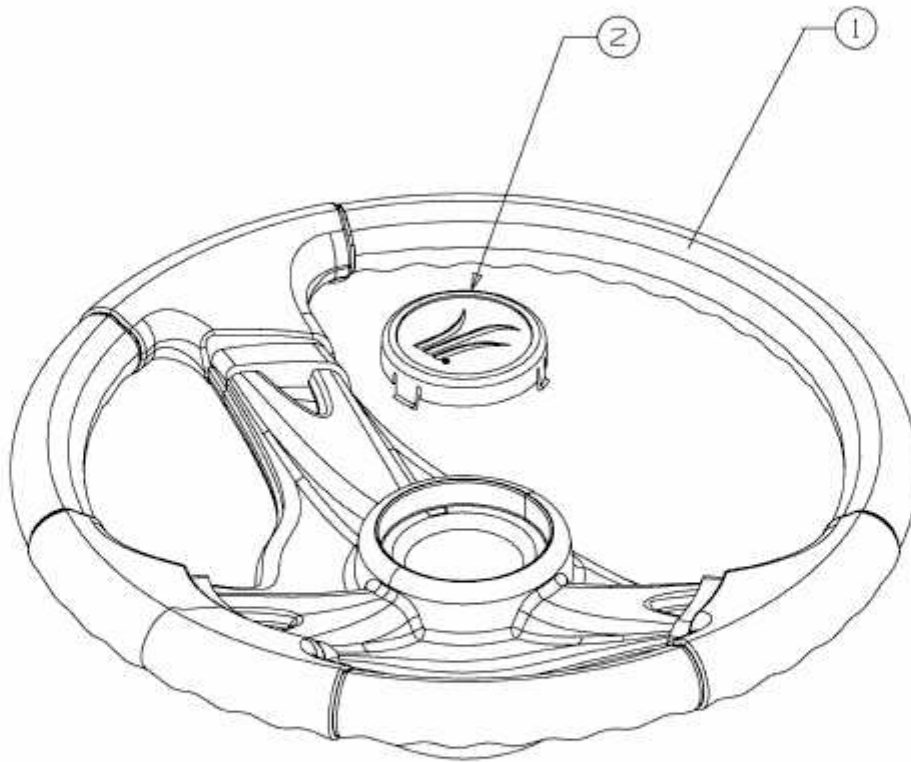

E3-02014B-01