

SMART RN 145 > 13HM76KN600 (2016) > MOTORHAUBE K-STYLE

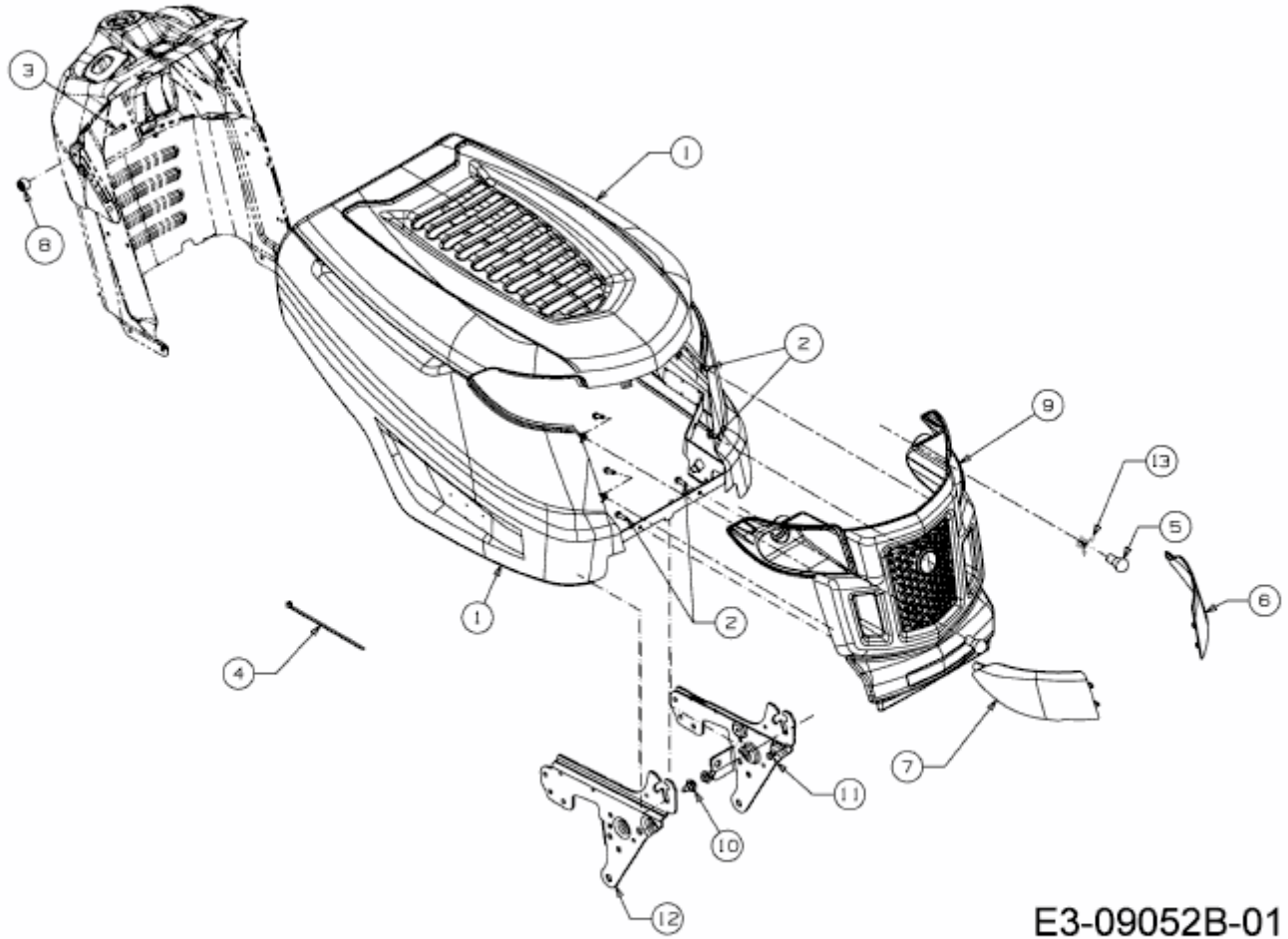

E3-09052B-01