

ab 29.01.2015
from 29.01.2015
à partir du 29.01.2015

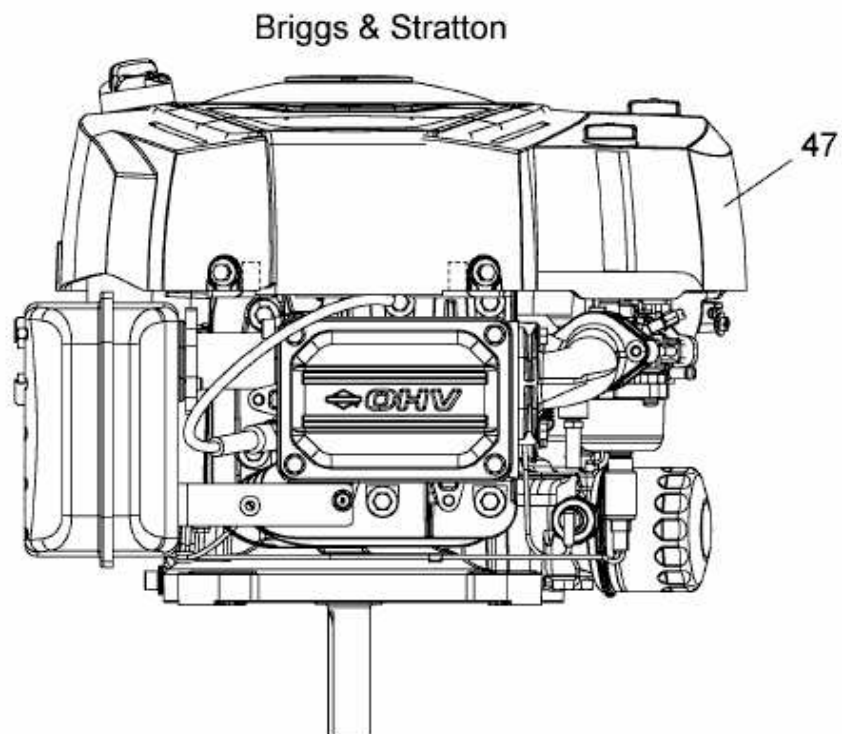

Model: 31Q507
Type: 0012H1

E3-09054A-03