

ab 04.03.2014
from 04.03.2014
à partir du 04.03.2014

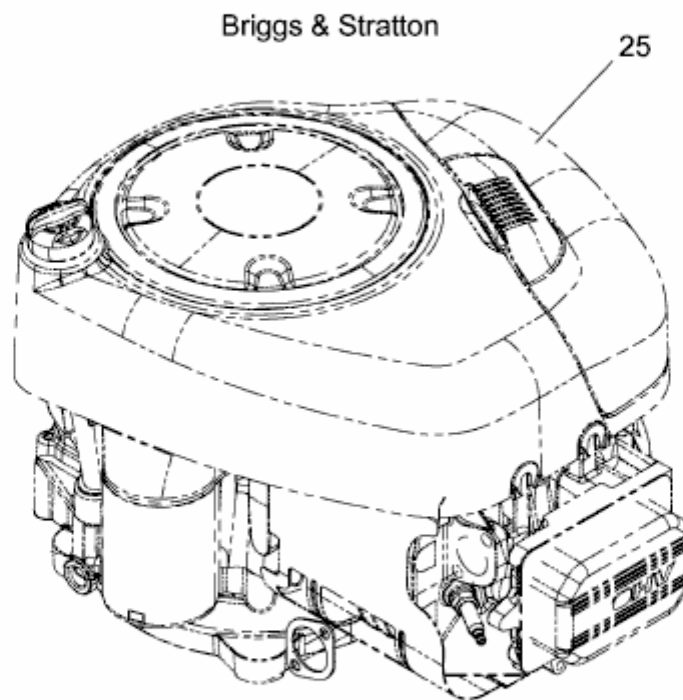

Model: 31Q507
Type: 0008H1

E3-02453A-04