

MASTERCUT 92-155 AB 2017 > 13HM765E659 (2017) > GESCHWINDIGKEITSREGELUNG

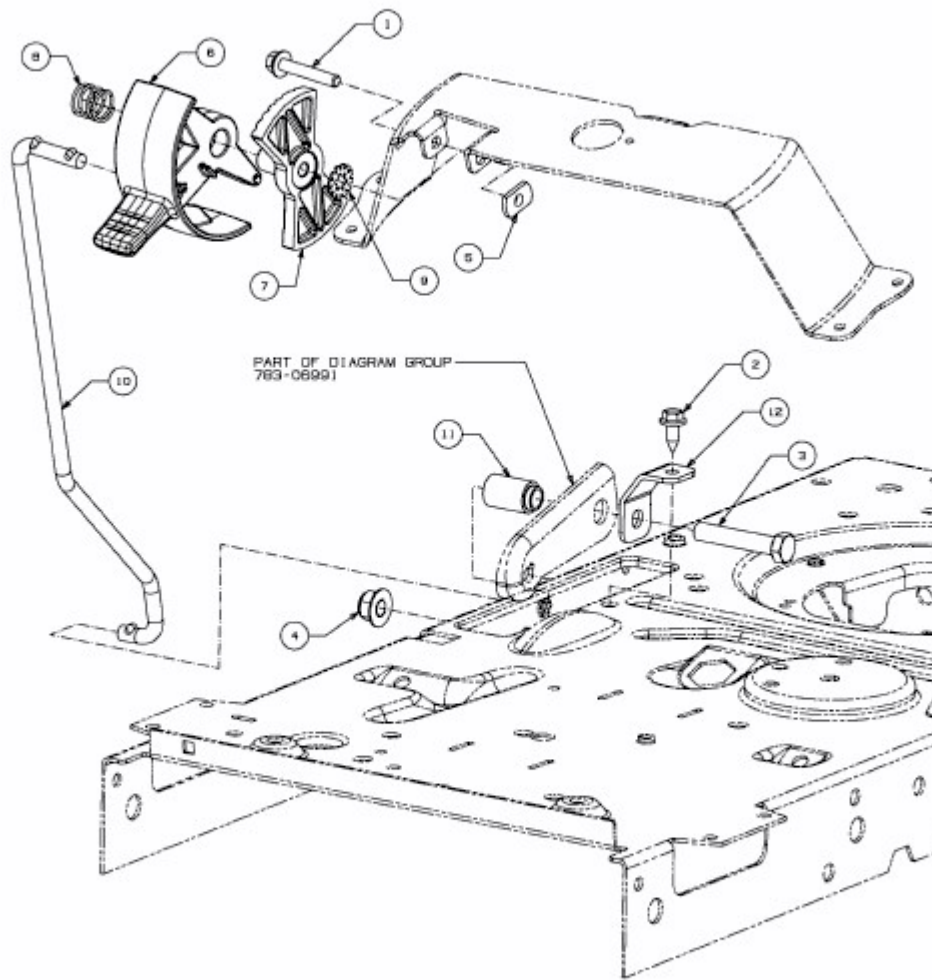

E3-07438B-01