

MASTERCUT 92-155 BIS 2016 > 13HM761E659 (2016) > GETRIEBE

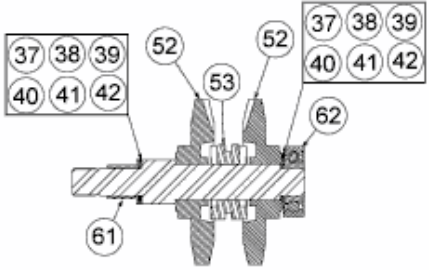
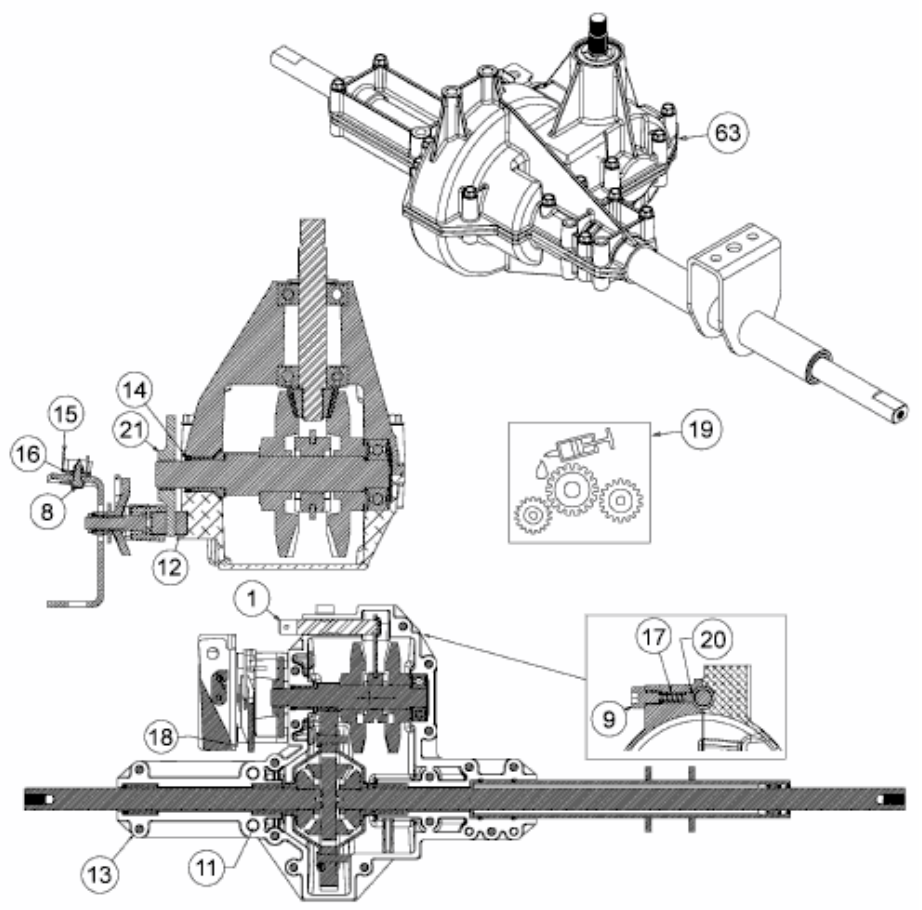
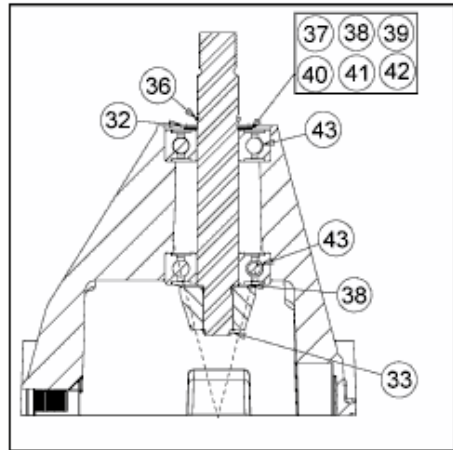

max. Axialspiel
max. axial backlash
max. jeu sur l'axe
0,004" - 0,008"

E3-03859G-02