

MASTERCUT 92-155 BIS 2016 > 13HM761E659 (2016) > GESCHWINDIGKEITSREGELUNG

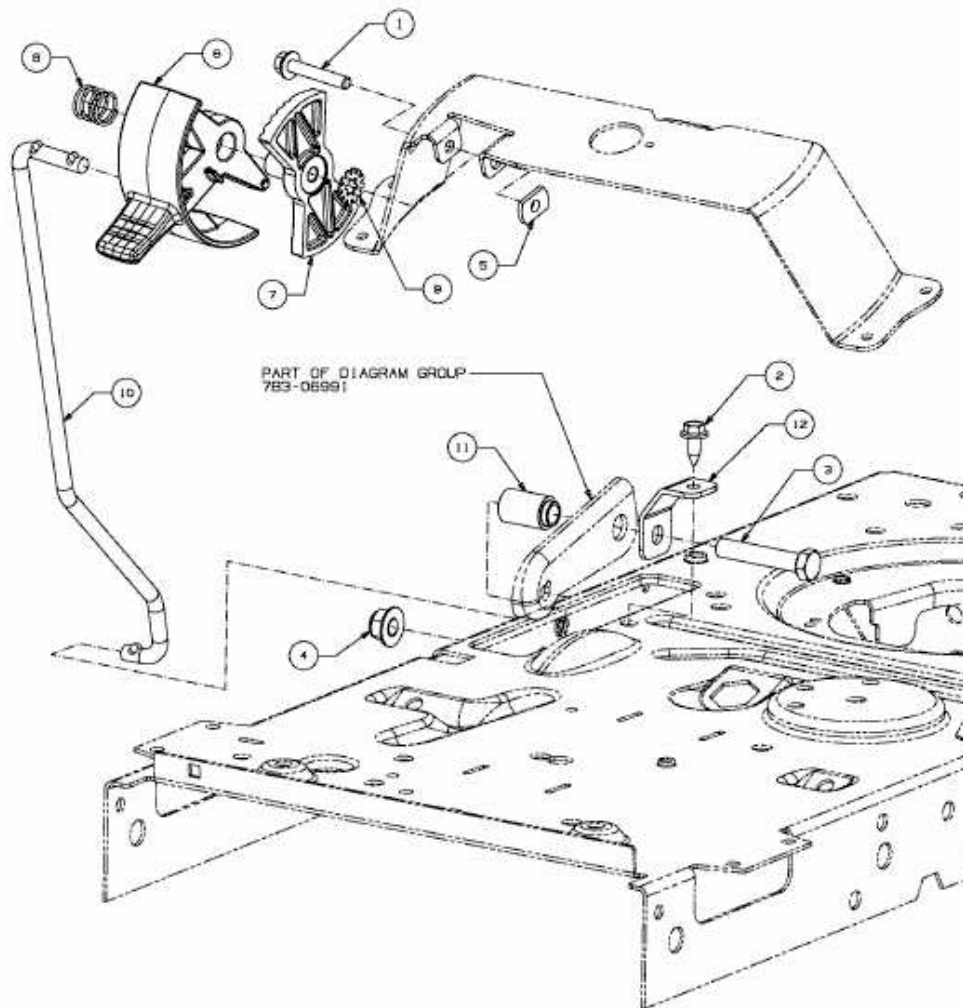

E3-07438B-01