

bis 19.12.2014
to 19.12.2014
jusqu'au 19.12.2014

Briggs & Stratton

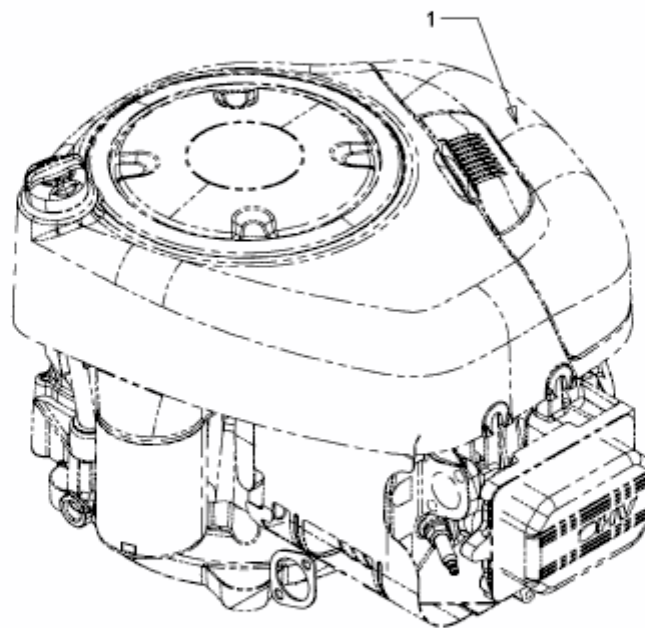

Model: 31R877
Type: 0012B1

E3-02483A-06