

ab 07.11.2016  
from 07.11.2016  
à partir du 07.11.2016

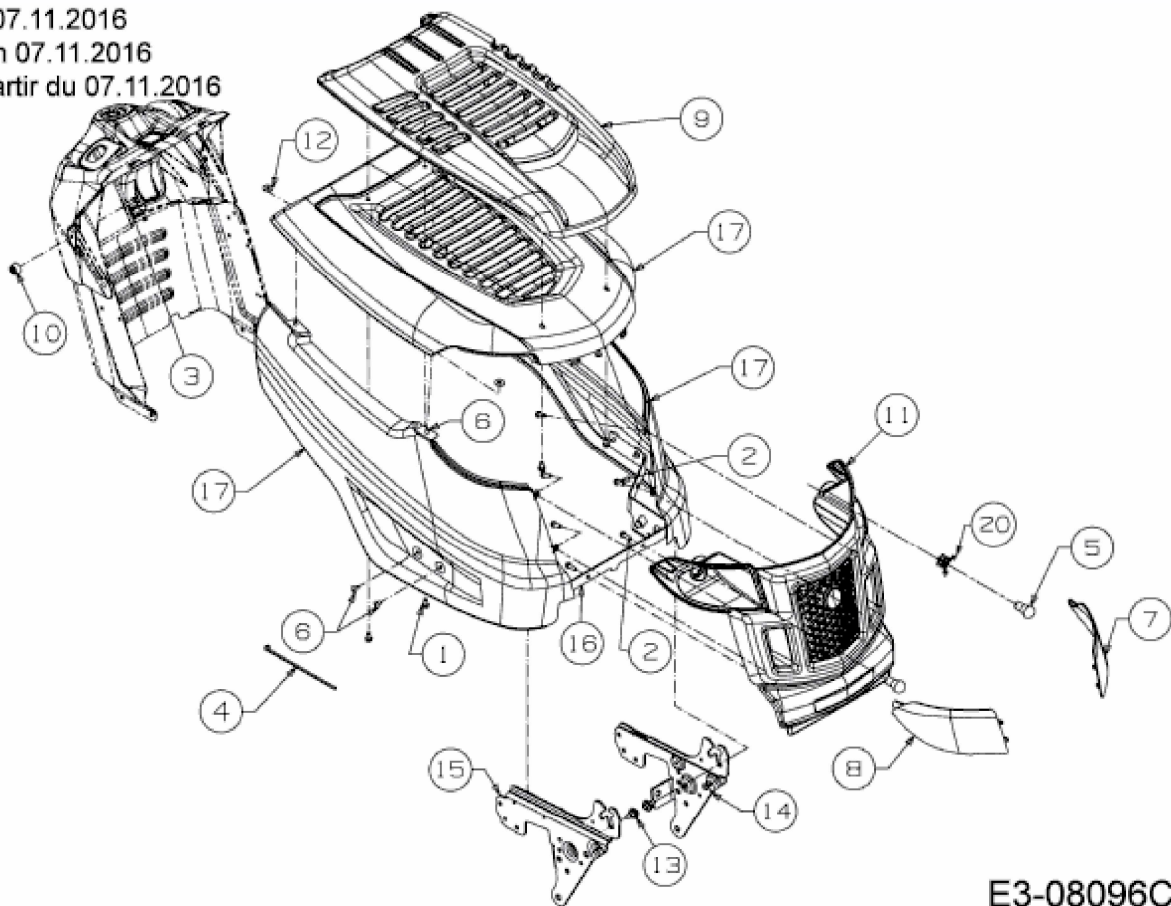

E3-08096C-02