

ab 01.12.2014  
from 01.12.2014  
à partir du 01.12.2014

Briggs & Stratton

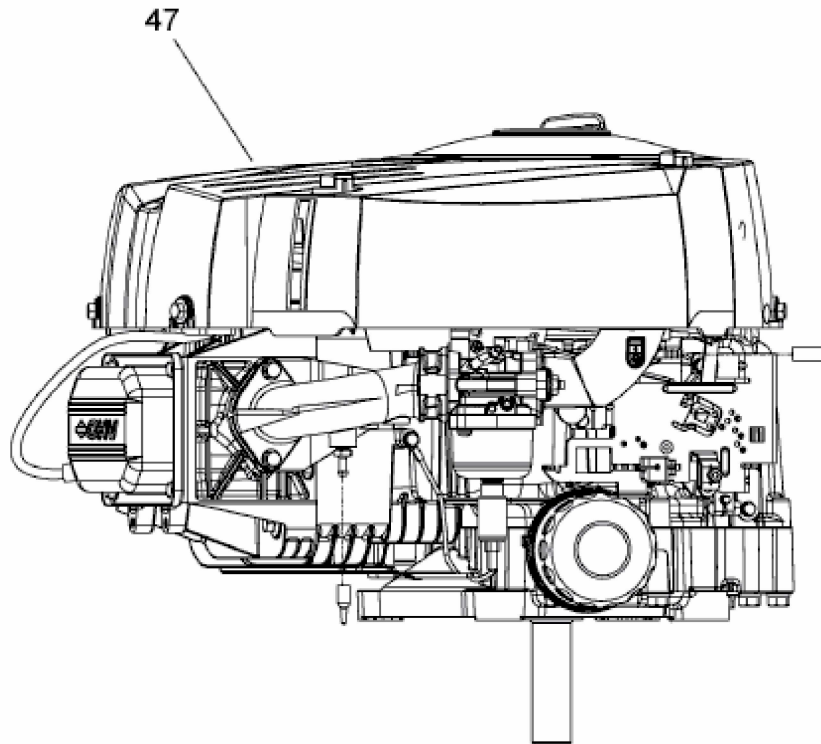

Model: 31R877  
Type: 0027B1

E3-09086A-01