

4

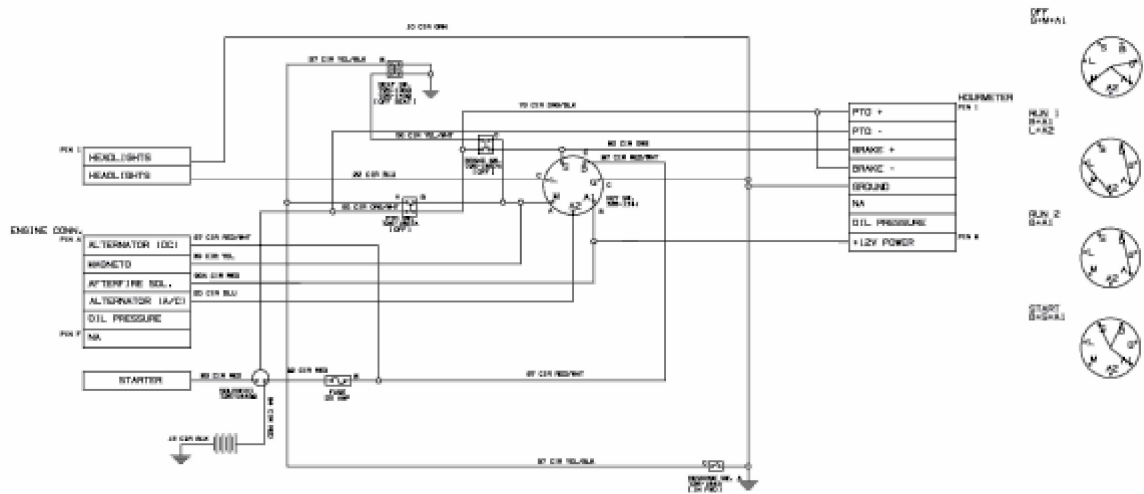

E3-09145A-02