

BL 125/92 T > 13HH771E683 (2016) > GESCHWINDIGKEITSREGELUNG

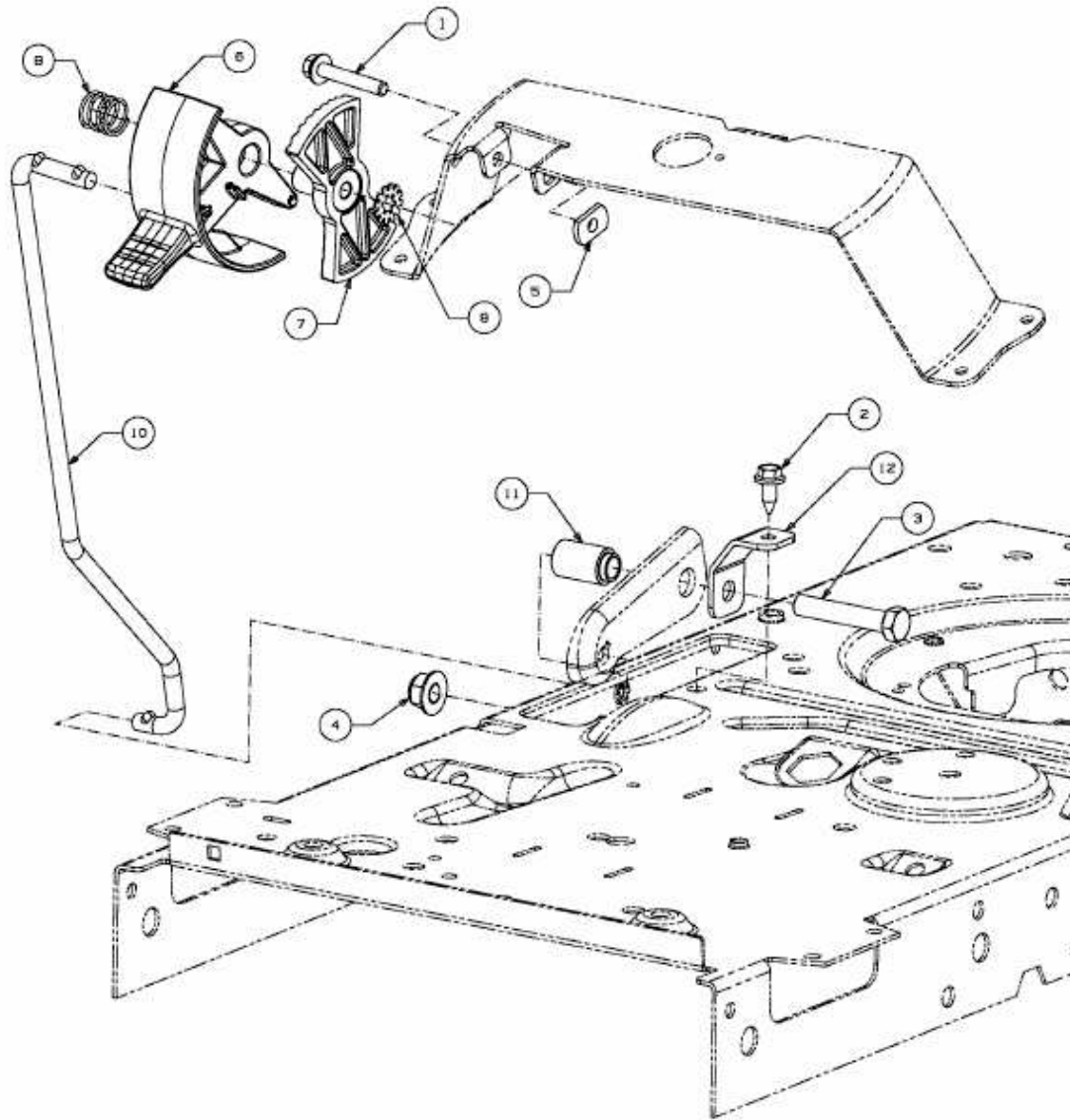

E3-07427B-01