

ab 17.02.2017
from 17.02.2017
à partir du 17.02.2017

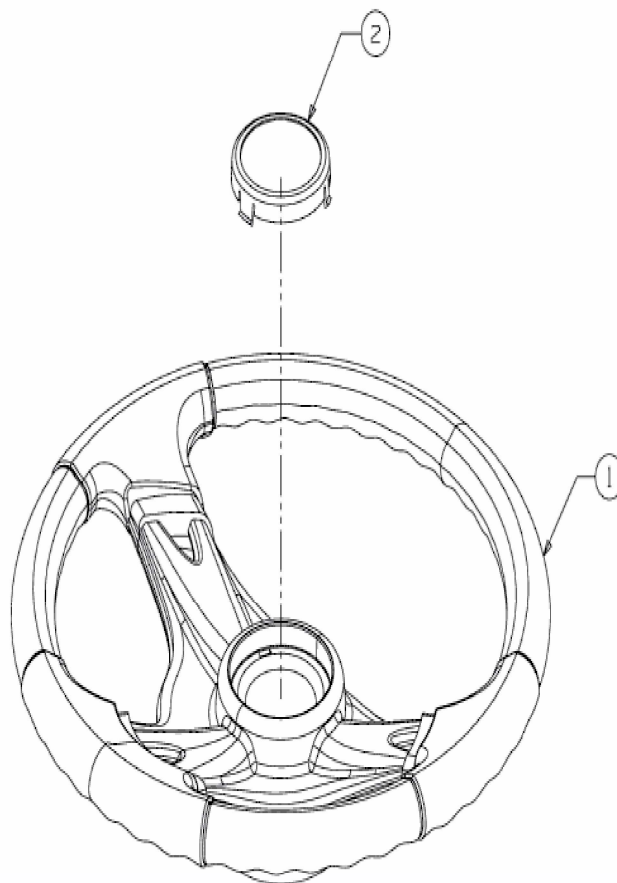

E3-02015A-04