

SMART RF 125 > 13HH76KF600 (2017) > SPANNROLLE GETRIEBE

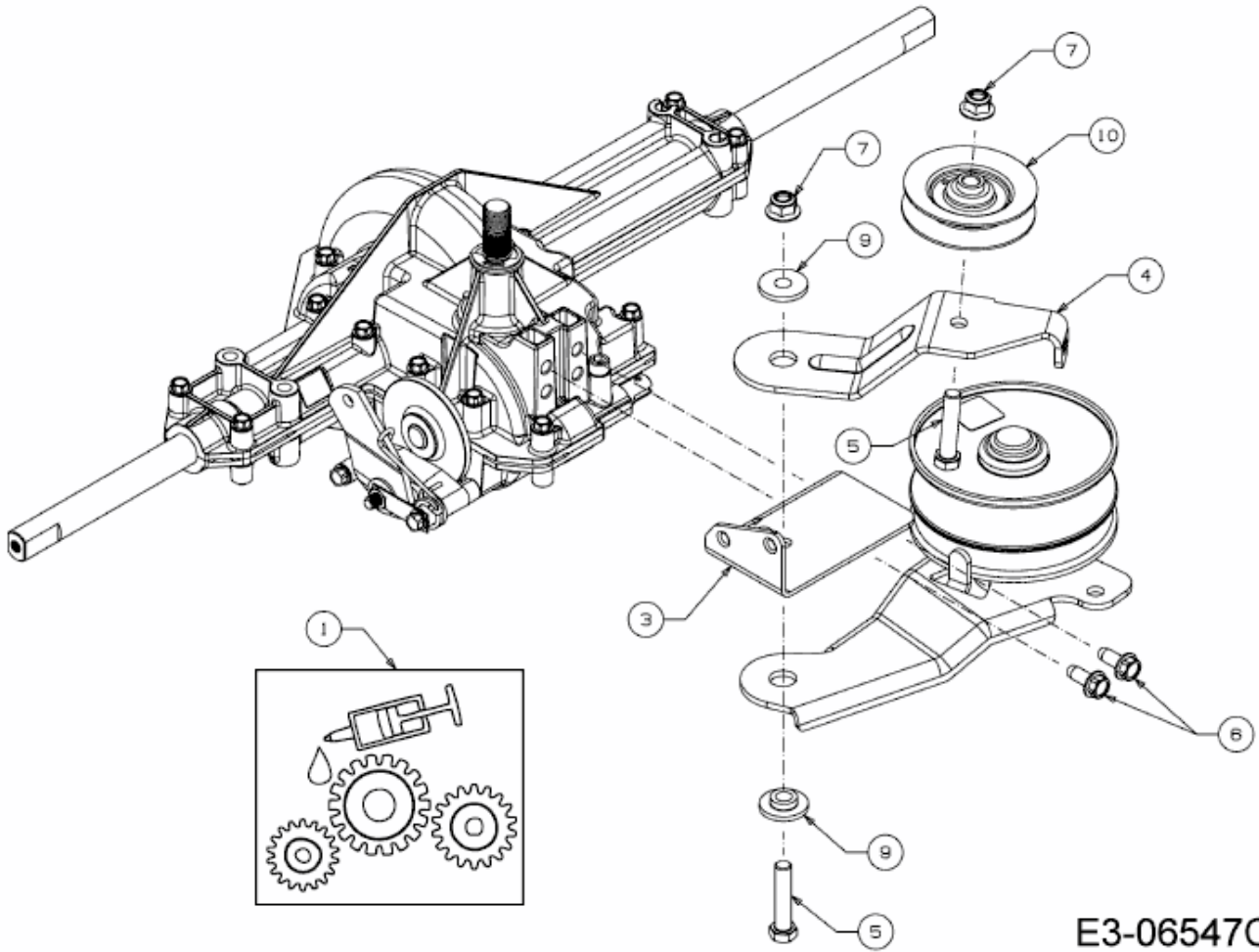

E3-06547C-02