

SMART RE 125 > 13HH76KE600 (2016) > SITZTRÄGER

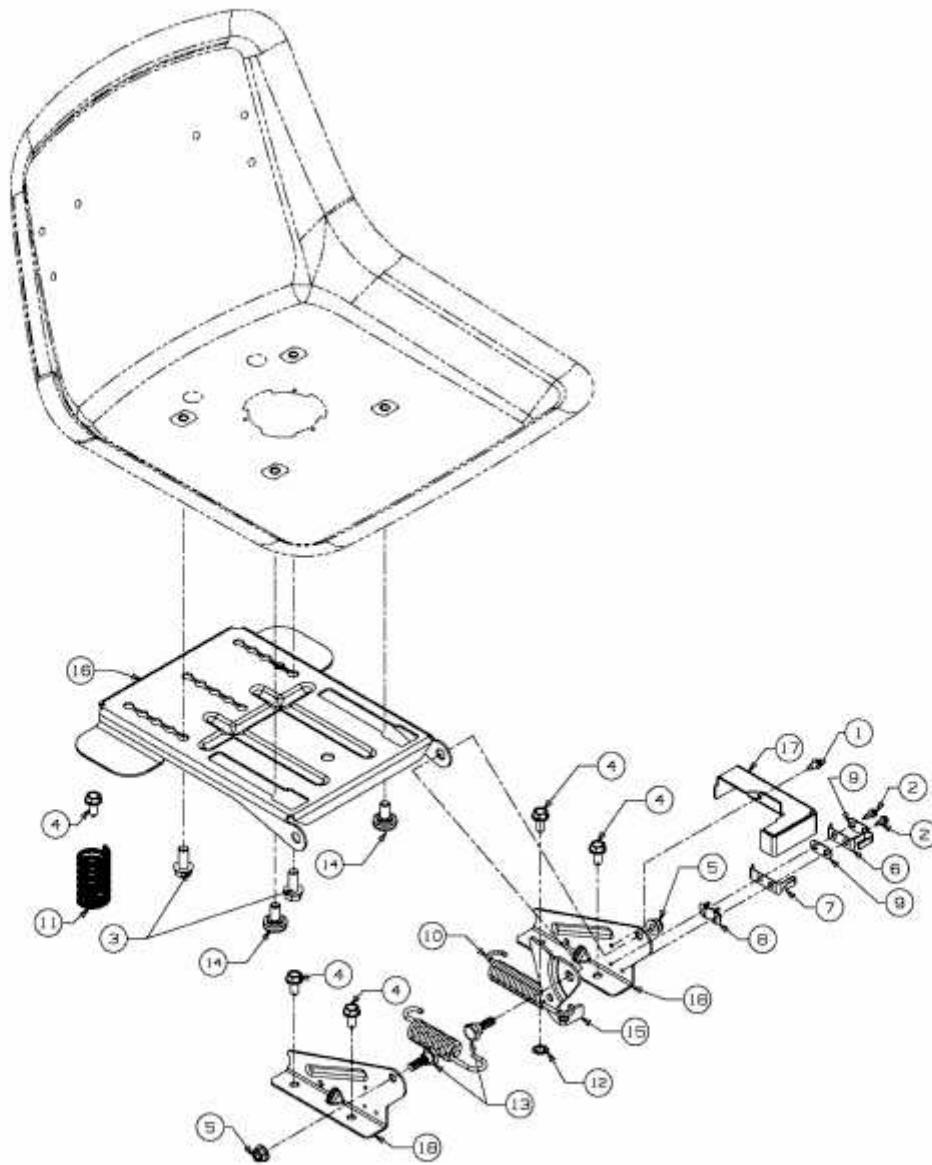

E3-02482B-01