

ab 29.09.2014
from 29.09.2014
à partir du 29.09.2014

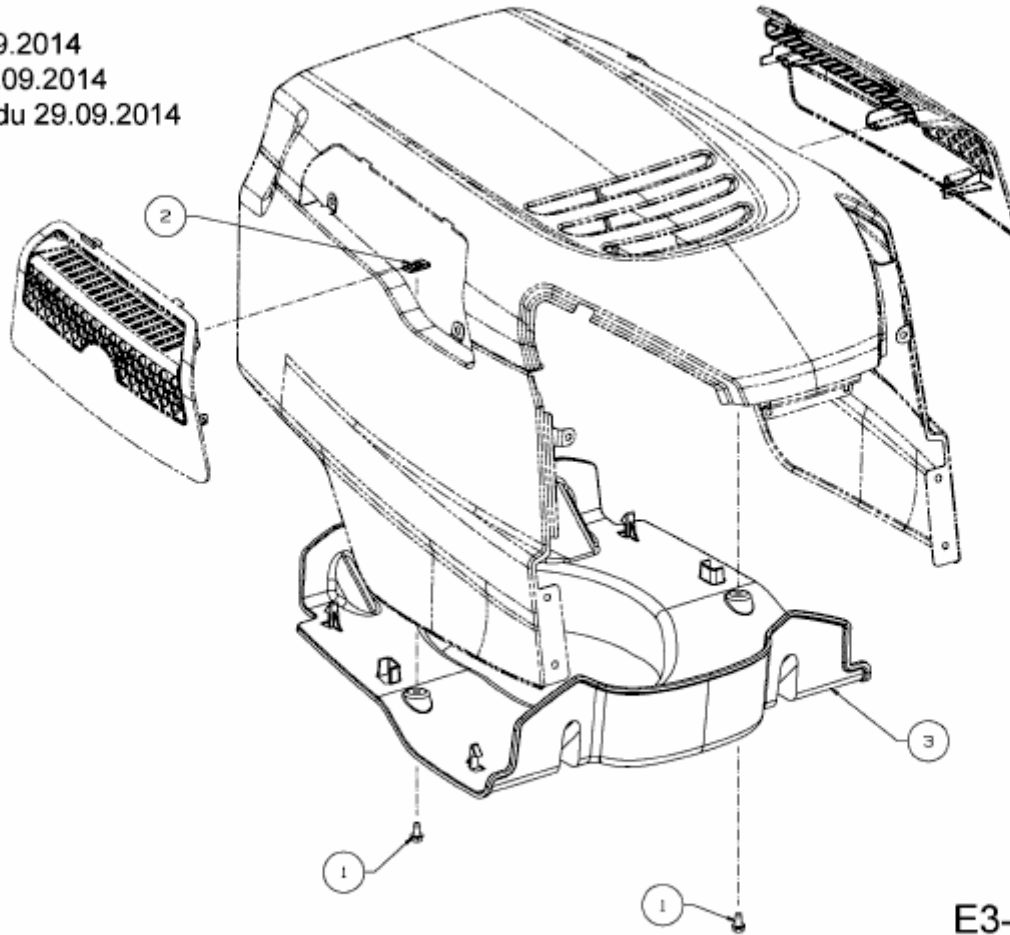

E3-08914A-01