

ab 16.10.2014
from 16.10.2014
à partir du 16.10.2014

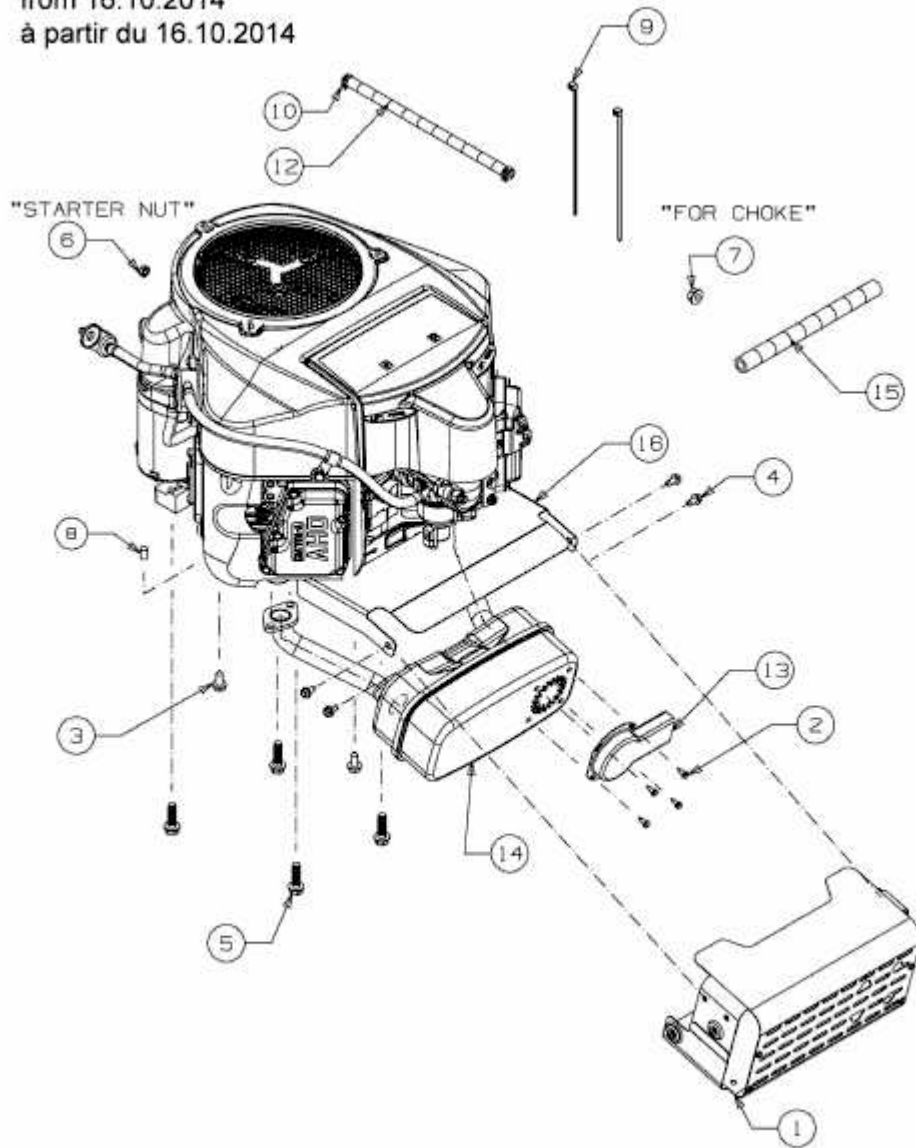

E3-09088A-02