

ab 03.02.2015
from 03.02.2015
à partir du 03.02.2015

Briggs & Stratton

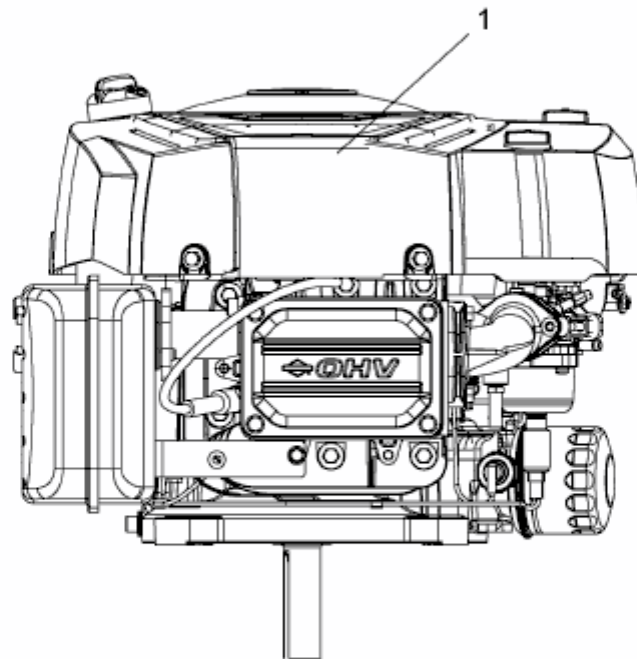

Model: 31R777
Type: 0036B1

E3-09059A-01