

ab 13.03.2014
from 13.03.2014
à partir du 13.03.2014

Briggs & Stratton

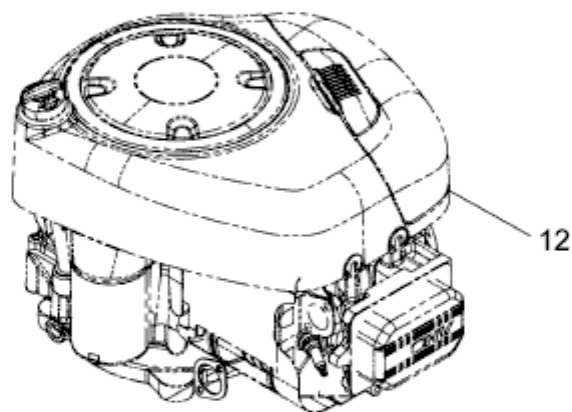

Model: 31R577
Type: 0017B1

E3-02495A-02