

ab 25.11.2014
from 25.11.2014
à partir du 25.11.2014

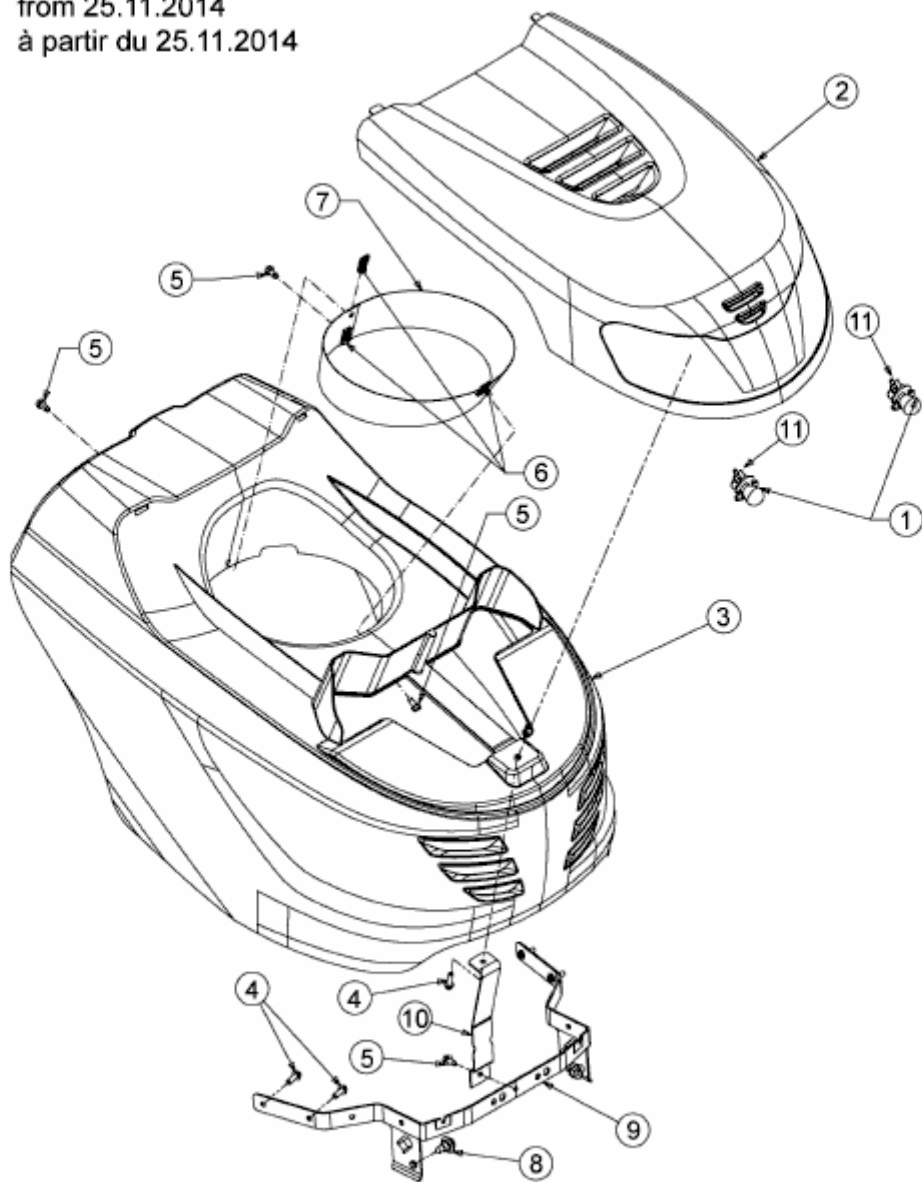

E3-09126A-01