

ab 20.04.2015
from 20.04.2015
à partir du 20.04.2015

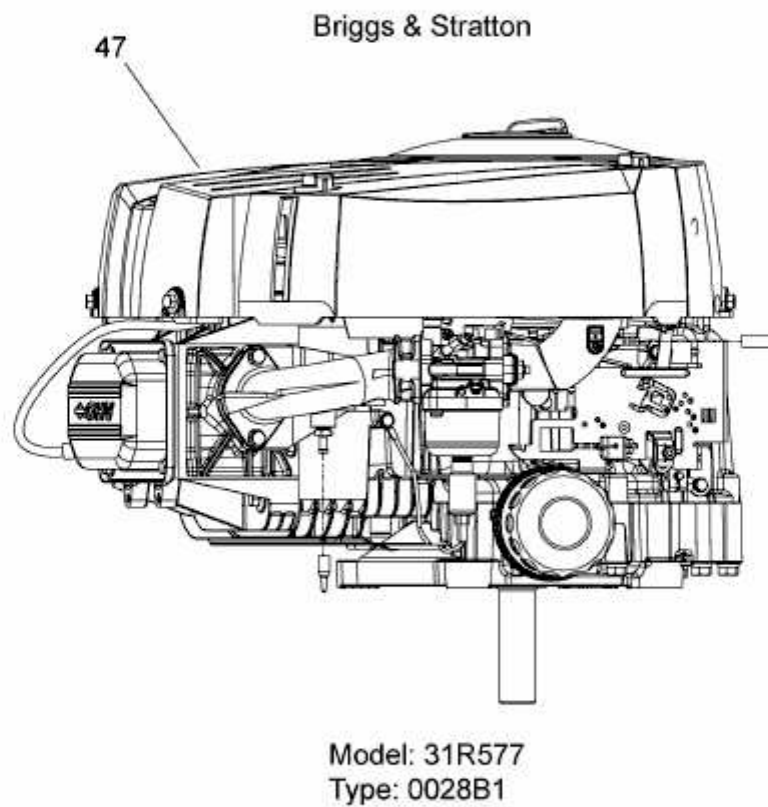

E3-09085A-03