

ab 11.02.2014
from 11.02.2014
à partir du 11.02.2014

Briggs & Stratton

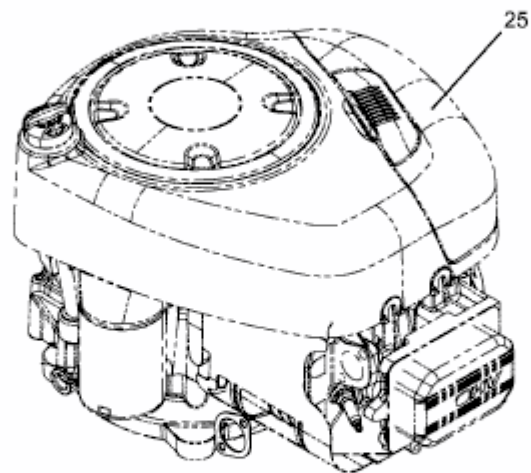

Model: 31R777
Type: 0018B1

E3-02468A-01