

ab 18.12.2014
from 18.12.2014
à partir du 18.12.2014

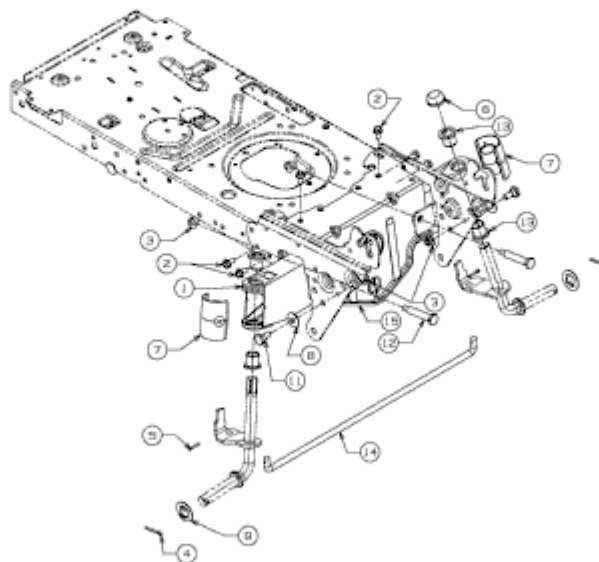

E3-04363C-02