

ab 17.11.2016
from 17.11.2016
à partir du 17.11.2016

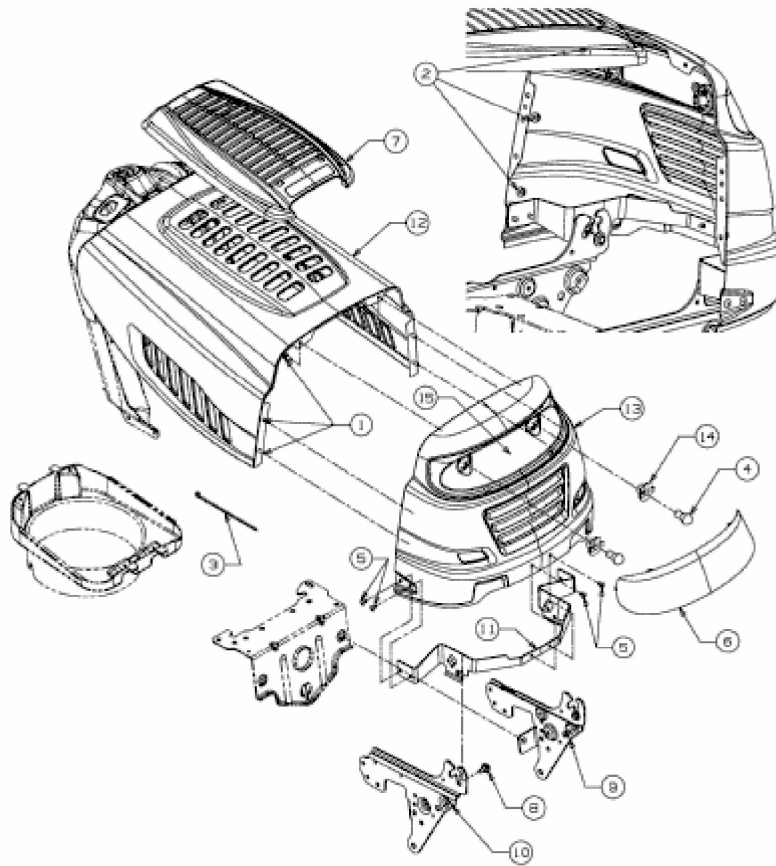

E3-07506B-02