

ab 01.07.2013
from 01.07.2013
à partir du 01.07.2013

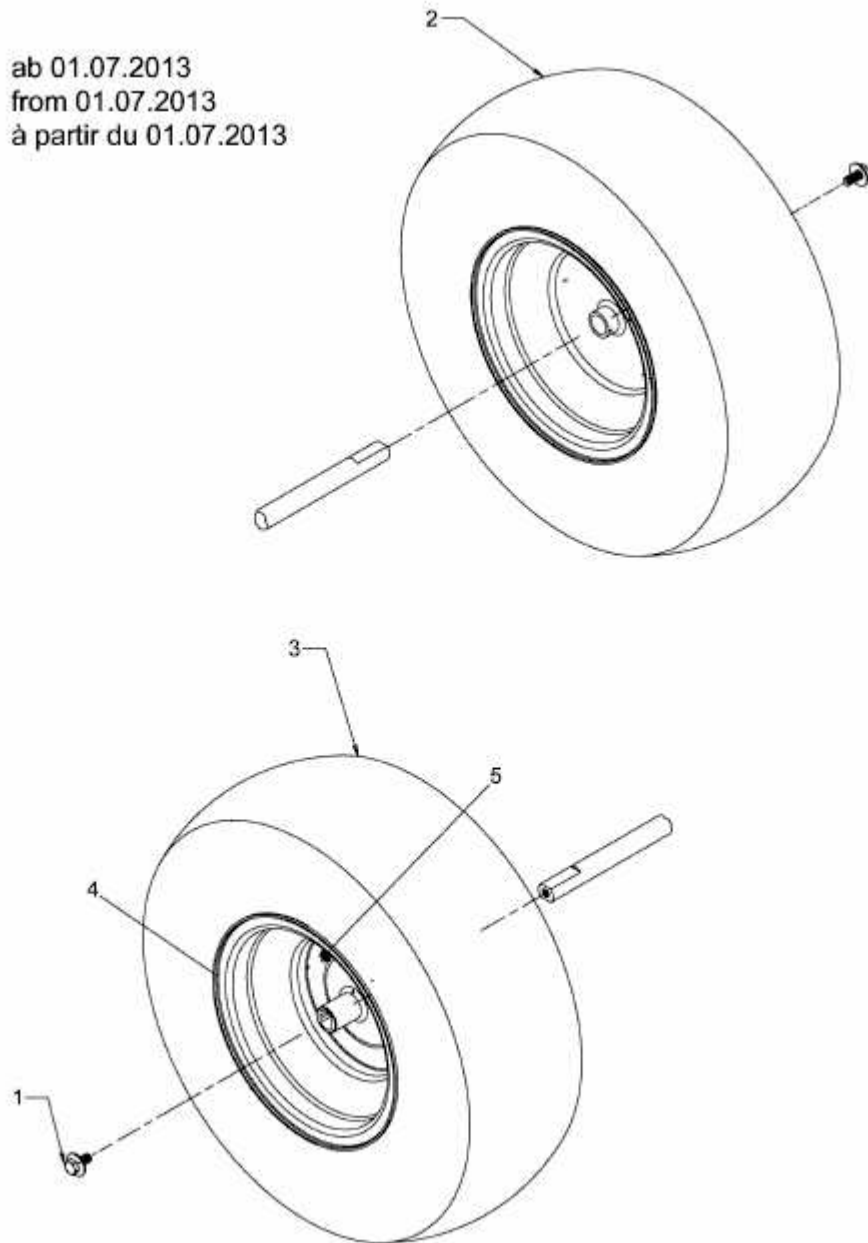

E3-05566B-01