

ab 01.11.2008
from 01.11.2008
à partir du 01.11.2008

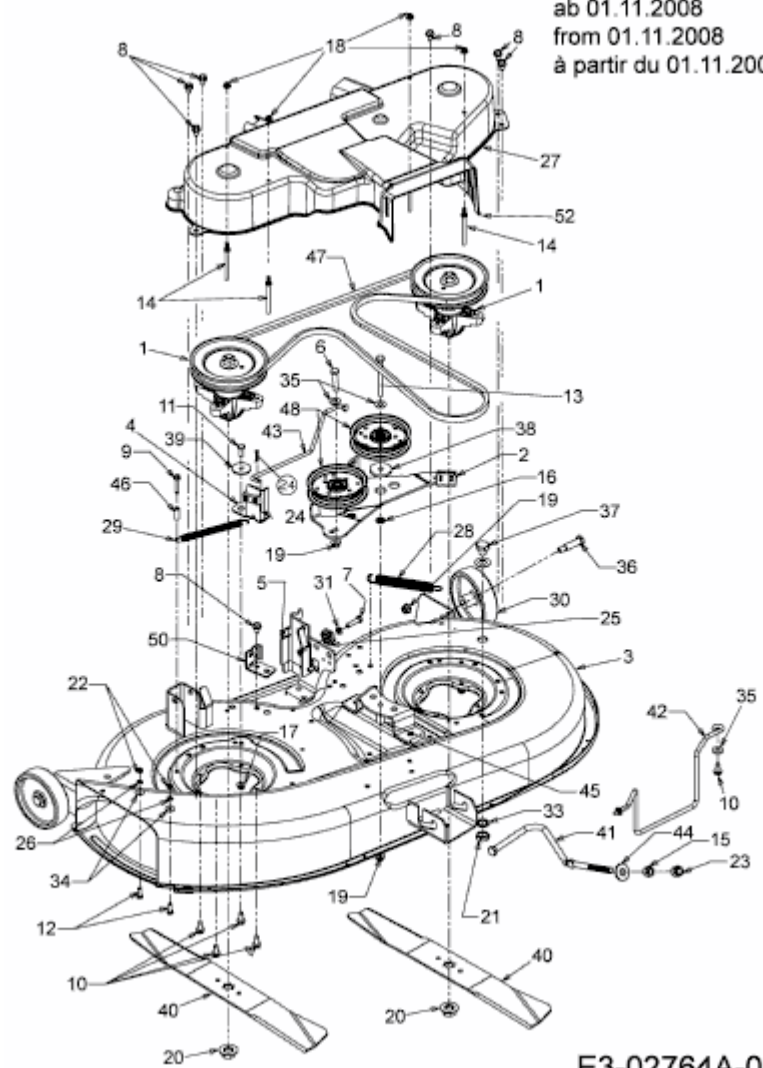

E3-02764A-03