

604 > 13DV479C611 (2007) > GESCHWINDIGKEITSREGELUNG

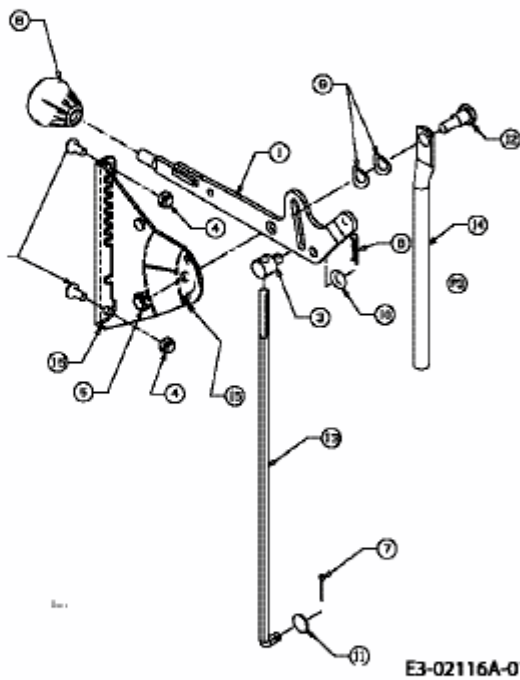

E3-02116A-01