

604 > 13DV479C611 (2006) > GESCHWINDIGKEITSREGELUNG

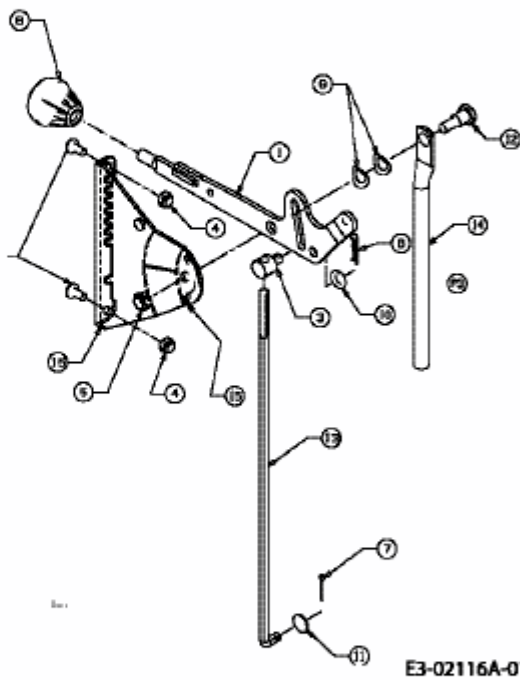

E3-02116A-01