

604 > 13DV479C611 (2005) > GESCHWINDIGKEITSREGELUNG

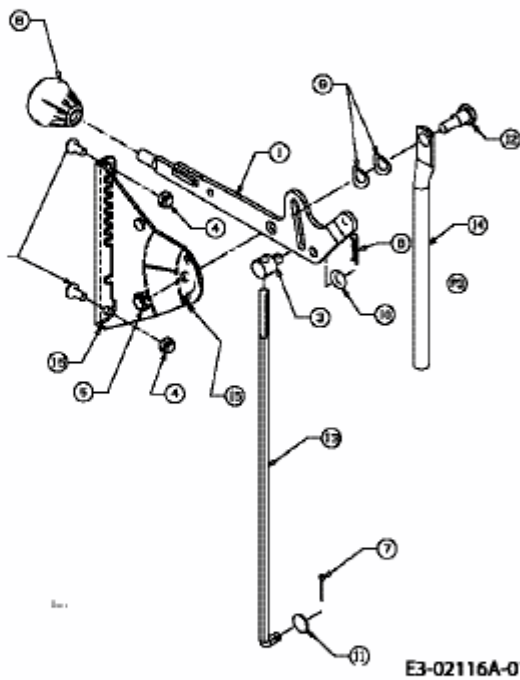

E3-02116A-01