

GLX 105 RH > 13DJ51GN690 (2011) > MÄHWERKSAUSHEBUNG

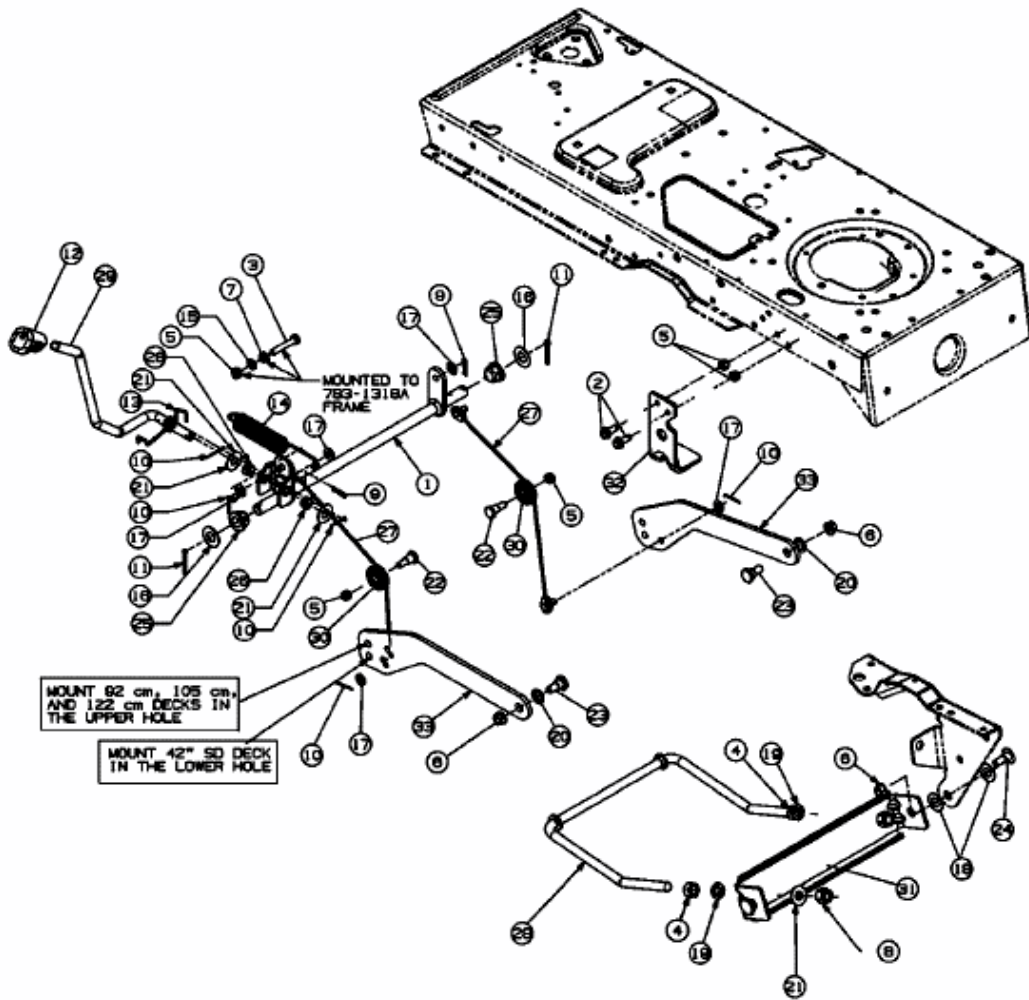

E3-02075A-01