

CC 1024 RD-J > 13DI51AJ603 (2011) > MOTORKEILRIEMENSCHLEIBE

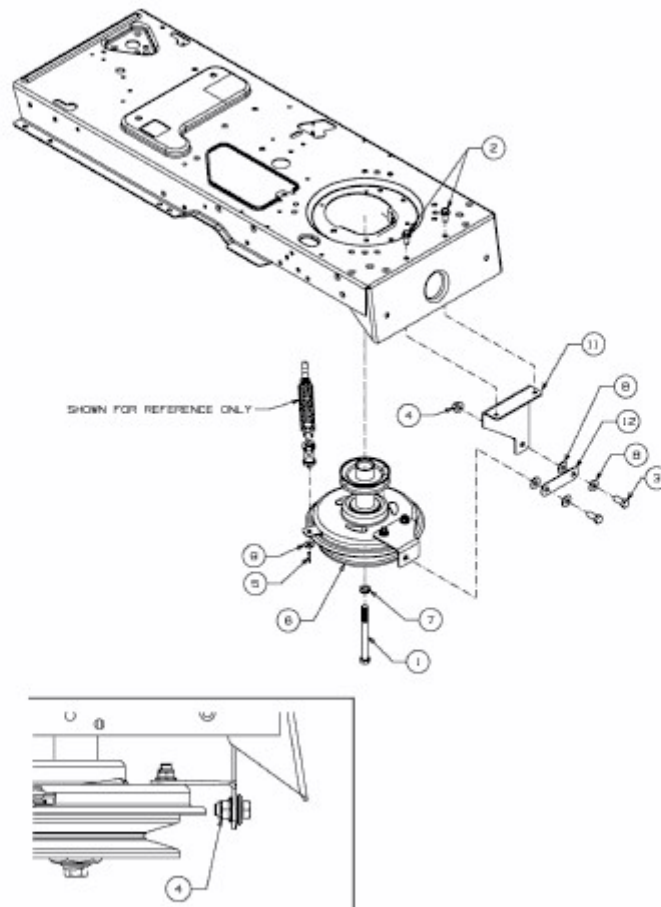

E3-05296A-01