

EP 135/96 > 13DH479F408 (2007) > TRITTBRETTBELAG

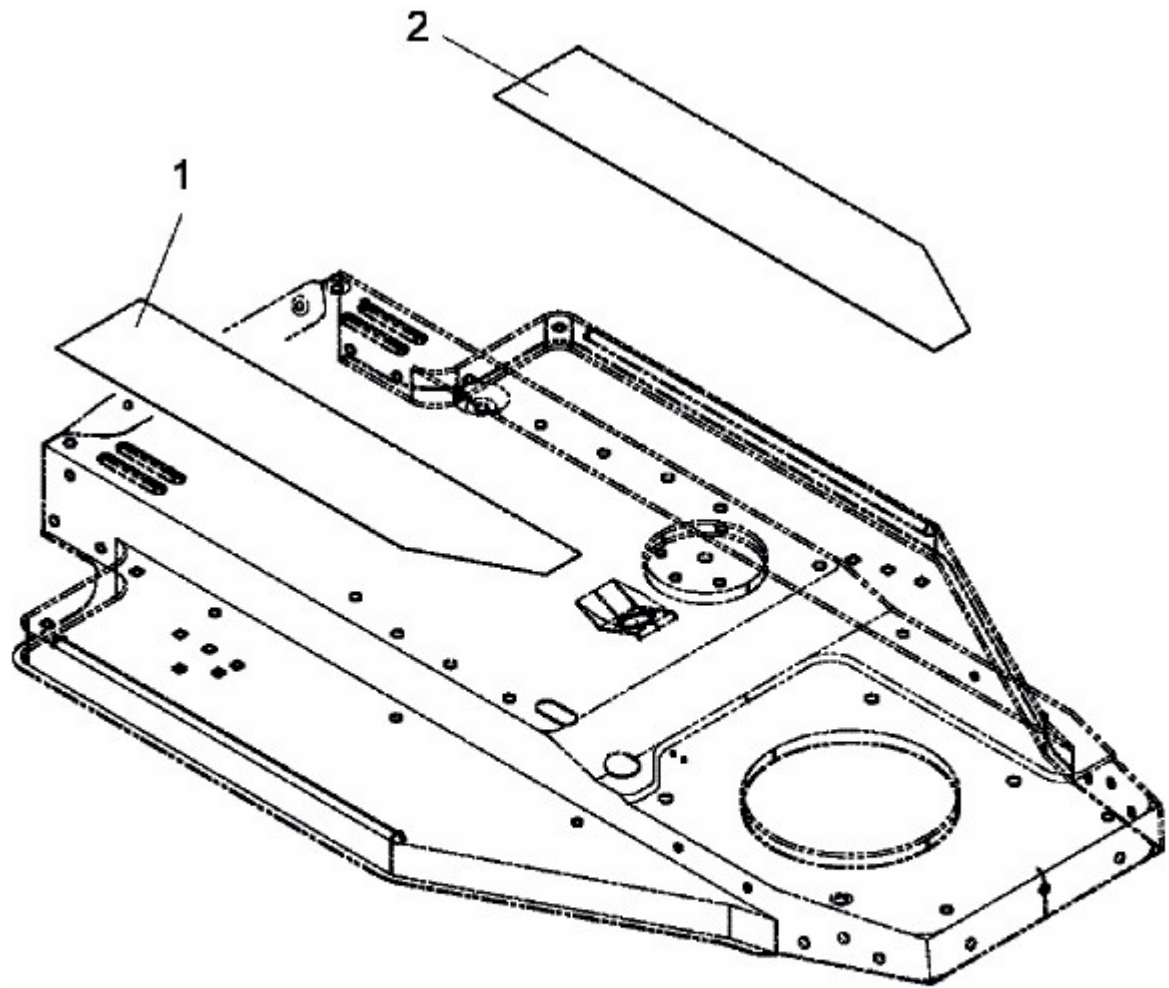

E3-02108A-01