

603 > 13DH479C611 (2007) > TANK

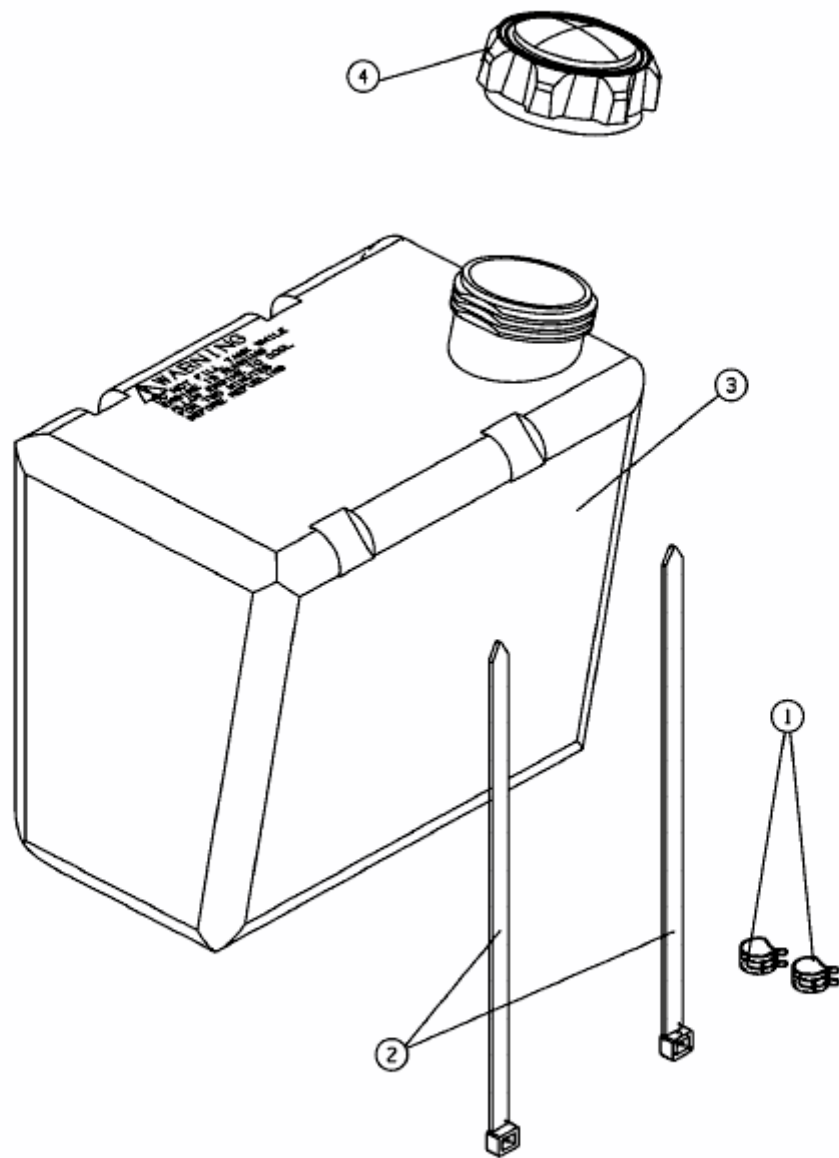

E3-02129A-01