

603 > 13DH479C611 (2007) > TRITTBRETTBELAG

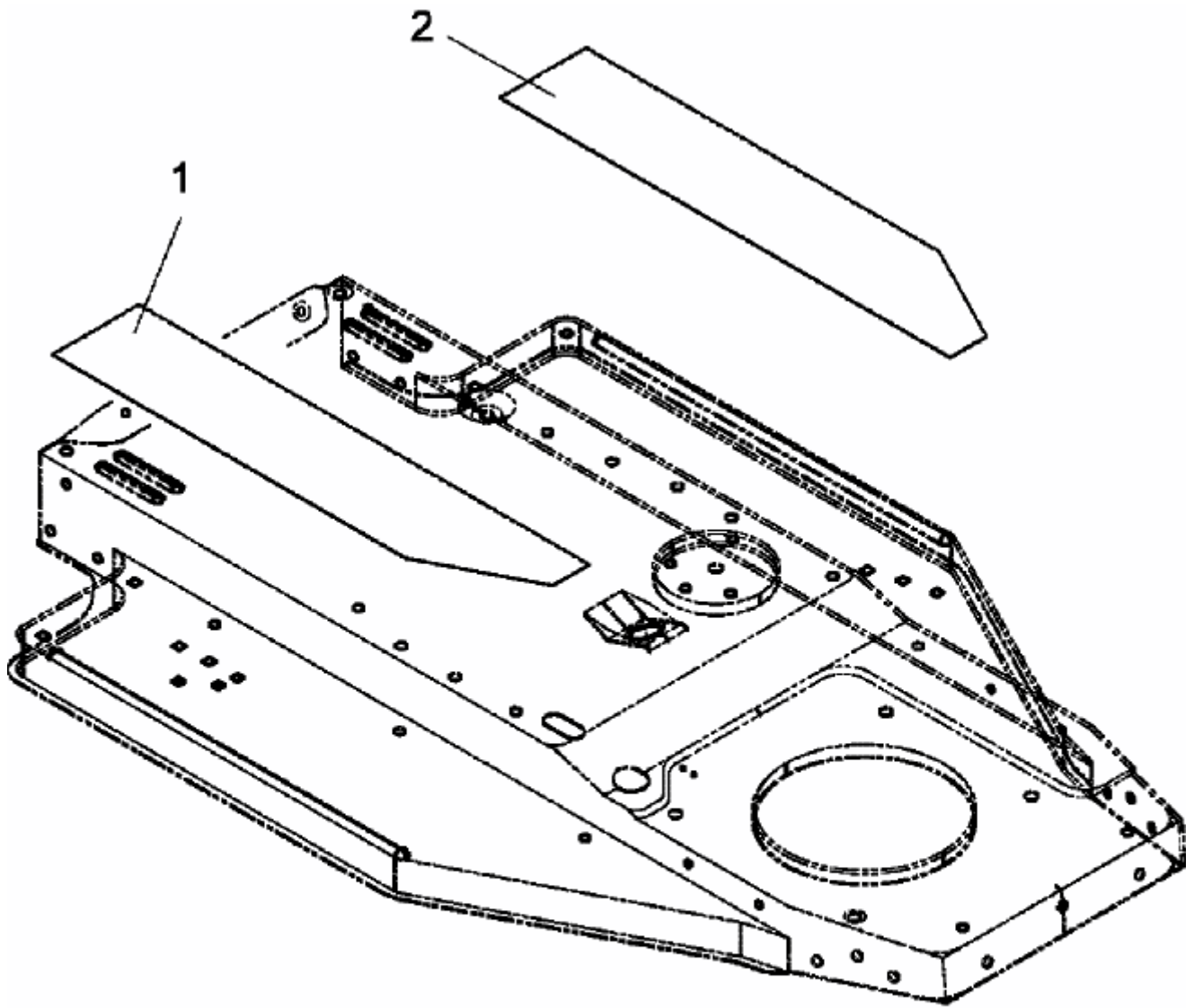

E3-02108A-01