

603 > 13DH479C611 (2007) > LENKUNG

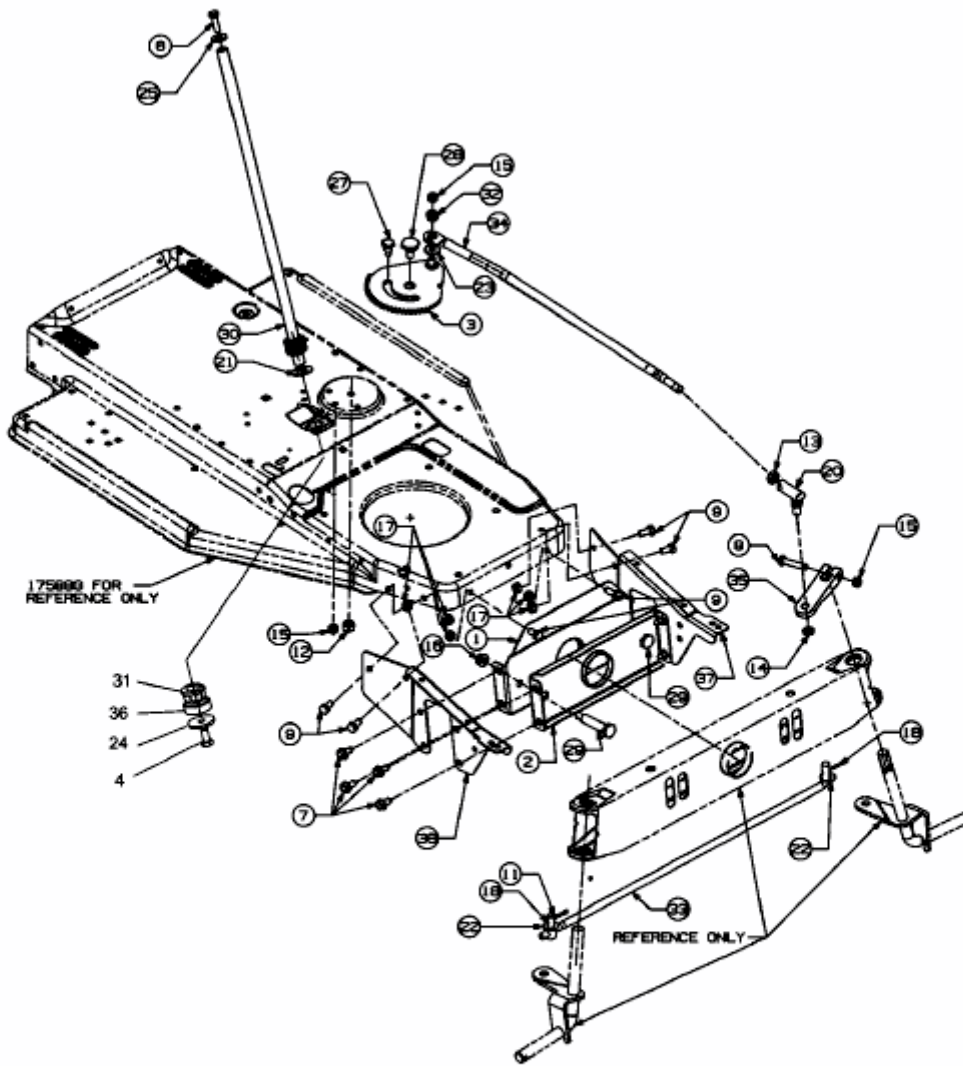

E3-02104A-01