

603 > 13DH479C611 (2006) > LENKRAD MIT LOGO

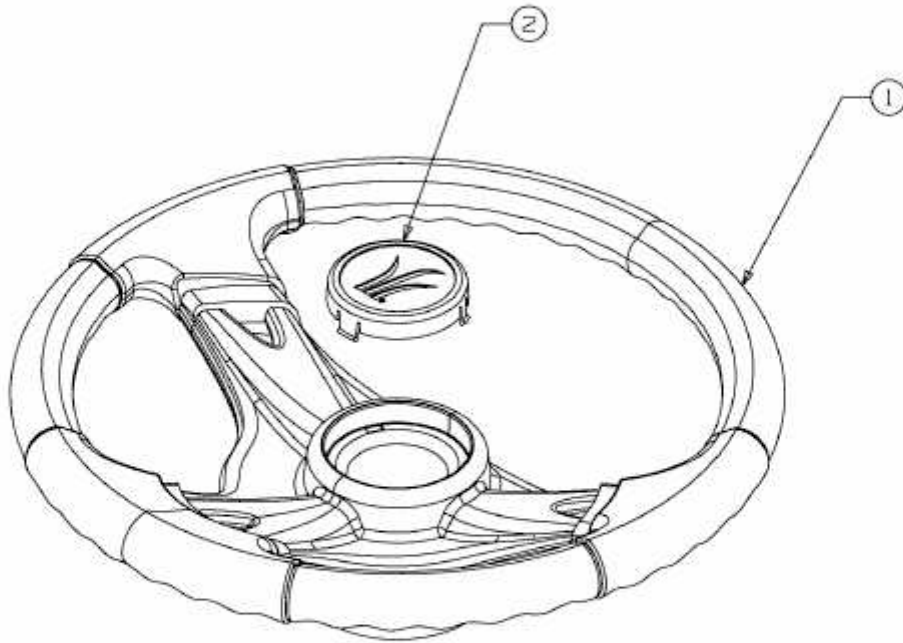

E3-02014A-01