

603 > 13DH479C611 (2006) > GESCHWINDIGKEITSREGELUNG

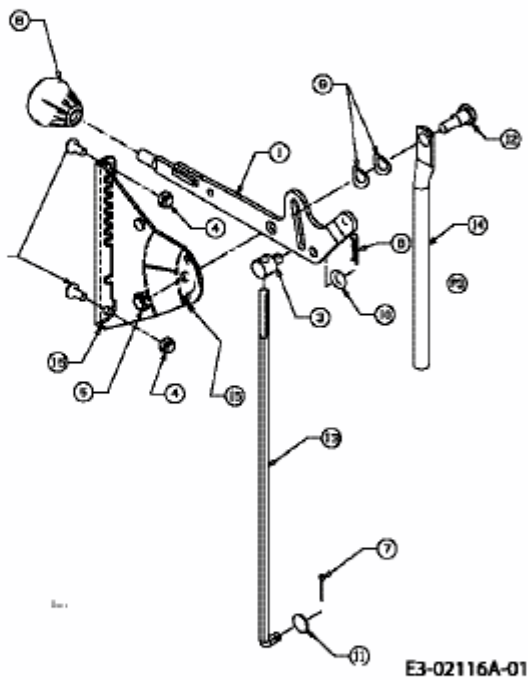

E3-02116A-01