

TA 4135 > 13DH474A643 (2007) > MOTORHAUBE 4-STYLE AB 27.09.2007

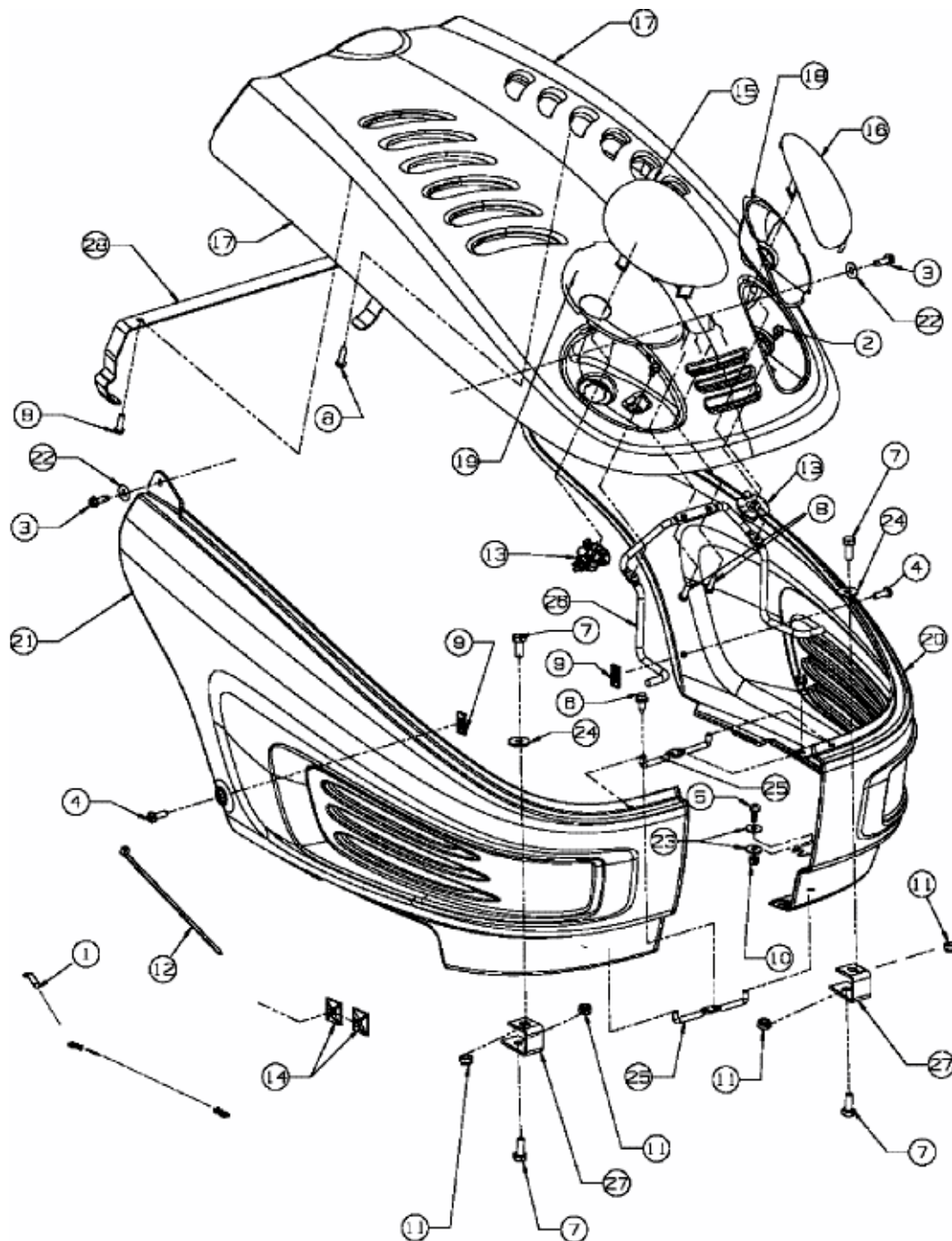

E3-02060B-01