

TA 4135 > 13DH474A643 (2007) > TRITTBRETTBELAG

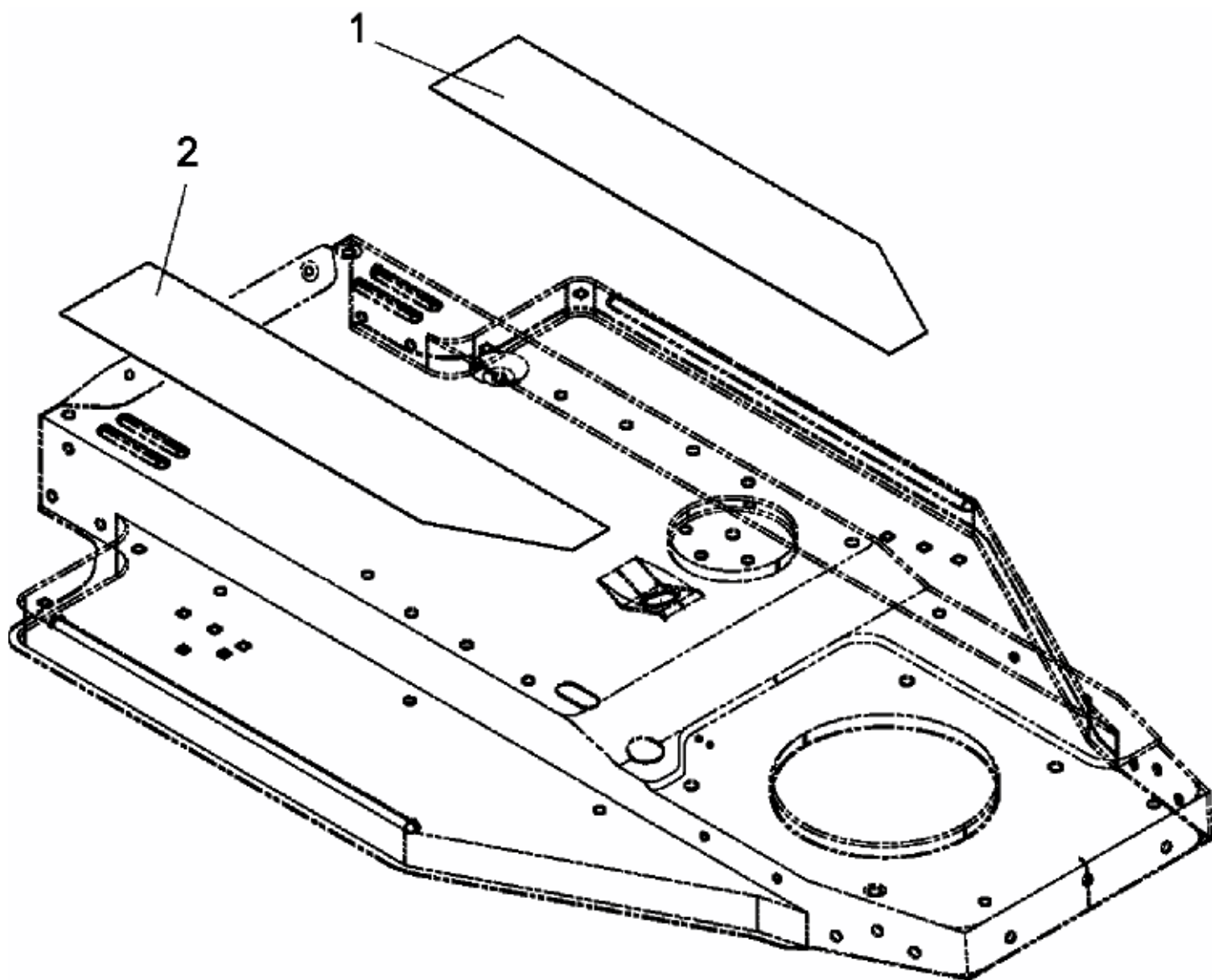

E3-02106B-01