

TA 4135 > 13DH474A643 (2007) > LENKUNG

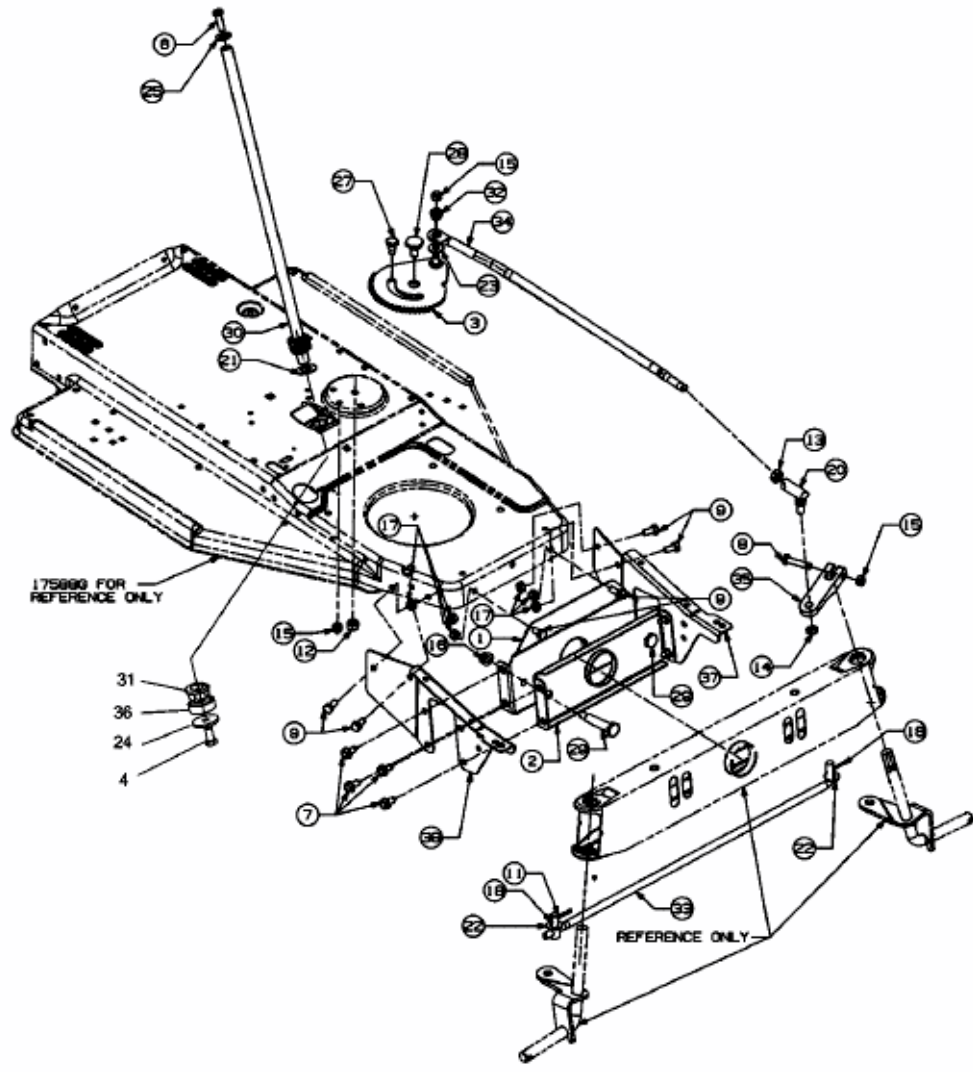

E3-02104A-01