

TA 4135 > 13DH474A643 (2007) > VORDERACHSE

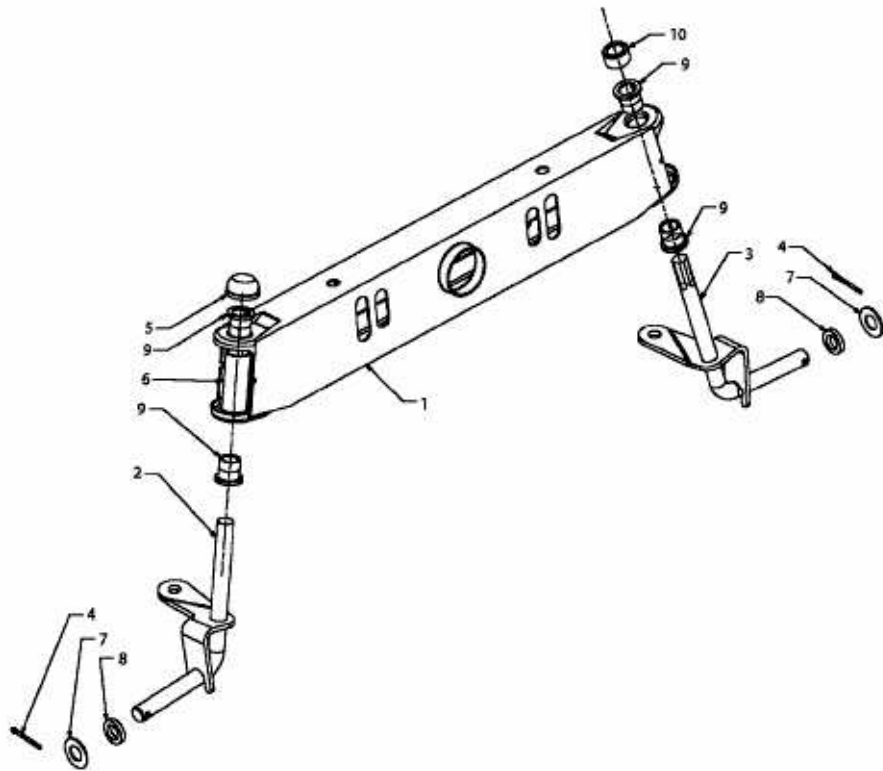

E3-02101A-01