

TA 4135 > 13DH474A643 (2007) > SITZWANNE

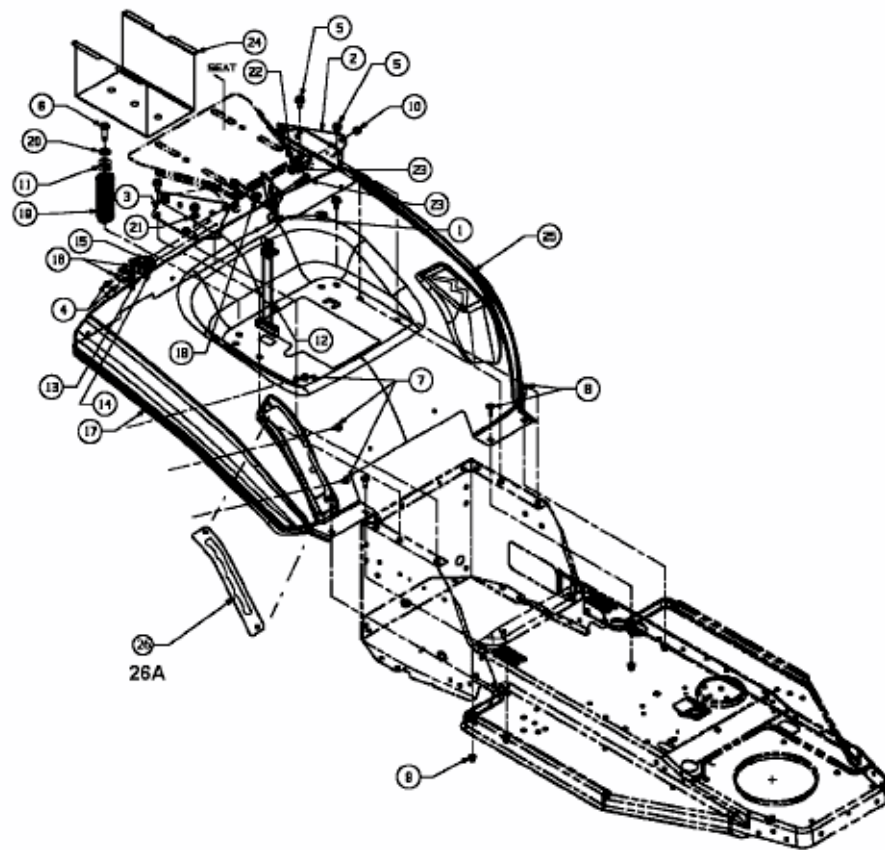

E3-02097A-01