

TA 4135 > 13DH474A643 (2006) > SITZTRÄGER

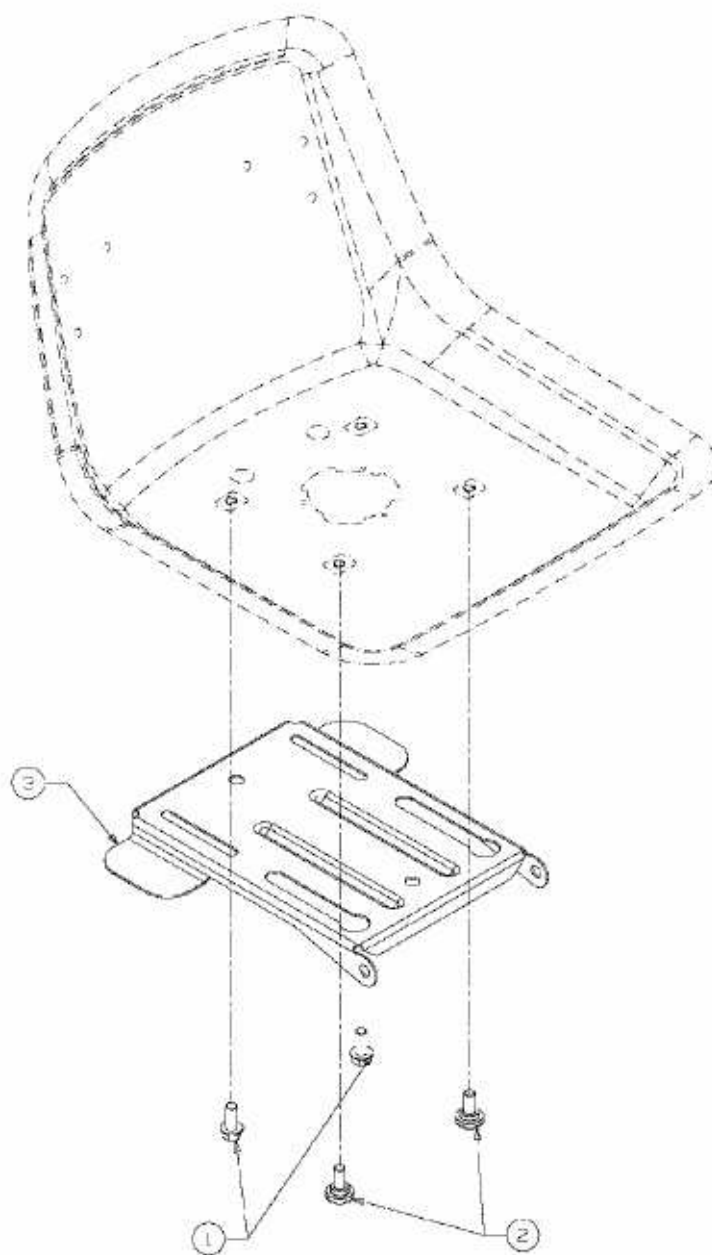

E3-02124B-01