

TA 4135 > 13DH474A643 (2006) > VORDERACHSE

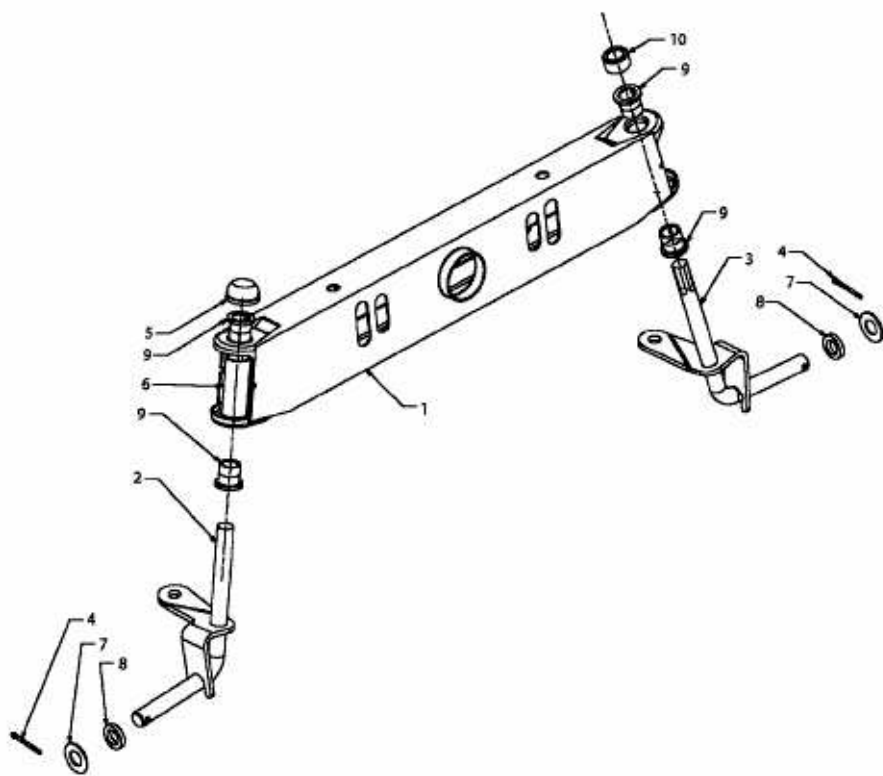

E3-02101A-01